



## QUARTZ™ ELECTRIC INSTALLATION GUIDE

# AQUALISA

## Important information

### Safety information

This appliance can be used by children aged from 3 years and above and persons with reduced physical, sensory or mental capabilities or lack of experience and knowledge if they have been given supervision or instruction concerning use of the appliance in a safe way and understand the hazards involved.

Children shall not play with the appliance.

Cleaning and user maintenance shall not be made by children without supervision.

The spray head must be descaled regularly.

**WARNING:** Do not switch on if there is a possibility that the water in the heater is frozen.

Fit only shower heads recommended by the manufacturer and never fit any additional device to restrict the water outlet flow.

The outlet must not be connected to any tap or fitting other than those specified.

This appliance is intended to be permanently connected to the water mains and not connected by a hose set.

A suitable double pole isolation switch for supply disconnections must be incorporated in the fixed wiring circuit, in accordance with current wiring rules. See Electrical Installation section for further details. his product must be installed by a competent person in accordance with all relevant current Water Supply Regulations.

**ALL SHOWERS REQUIRING AN ELECTRICAL CONNECTION MUST BE INSTALLED BY A QUALIFIED PERSON FOLLOWING THE LATEST REVISION OF BS 7671 (WIRING REGULATIONS) AND CERTIFIED TO CURRENT BUILDING REGULATIONS.**

**WITH REFERENCE TO BUILDING REGULATION PART P, ANY NEW INSTALLATION OR REPLACEMENT PRODUCT INSTALLATION WHICH IS NOT IDENTICAL TO THE PRODUCT BEING REPLACED, THE CABLE SIZES, CIRCUIT PROTECTIVE DEVICES, EARTH BONDING AND ALL OTHER REQUIREMENTS OF THE BUILDING REGULATION MUST BE ASSESSED BY A (REGISTERED) QUALIFIED ELECTRICIAN AND INSTALLED IN CONSIDERATION TO THE SITE CONDITIONS (see table below).**

### Introduction

Quartz Electric is a surface mounted instantaneous electric shower unit which is available in a choice of performance ratings – 8.5kW and 9.5kW available in White/chrome and 8.5kW, 9.5kW and 10.5kW available in Satin chrome and Graphite/chrome.

Quartz Electric's patented Over Temperature Protection (OTP) device ensures safer comfortable showering whilst the shower provides endless economical showering as it imposes no demand on stored hot water.

Quartz Electric is supplied with a 2 year guarantee.

If you have any questions at any stage during installation please contact the Aqualisa customer helpline on 01959 560010 for advice.

Shower rating @ 240V		8.5kW		9.5kW		10.5kW	
Nominal current @ 240V		35.4A		39.6A		43.8A	
MCB rating		40A		40A		45/50A	
Cartridge fuse		40/45A		40/45A		45A	
		Min cable size mm <sup>2</sup>	Max cable size mm <sup>2</sup>	Min cable size mm <sup>2</sup>	Max cable size mm <sup>2</sup>	Min cable size mm <sup>2</sup>	Max cable size mm <sup>2</sup>
Type of cable run	Installed in insulated wall	10	61	10	55	10	50
	Conduit or trunking	6	37	10	55	10	50
	Clipped direct or buried in uninsulated wall	6	37	6	33	10	50

Notes:

- Cable selection is dependant on de-rating factors detailed in the electrical rating section overleaf.
- In certain installations the combination of low voltage and extended cable lengths may result in loss of power and a consequential reduction in flow rates.
- Above cable sizes are the minimum acceptable sizes. Sizes greater than these shown above may be used and should be used if cable runs are greater than indicated (above cable runs are based on a maximum 9.6V drop).
- Reversible fuses are not recommended and are not covered by this table.
- Installation should be carried out by a qualified person. Please refer to BS7671 (Wiring Regulations) if in doubt.
- A 16mm<sup>2</sup> cable may be required for long cable runs.

Cables which are chased into the wall must be protected by the use of conduit or sheathing. Surface mounted cables must also be protected by a suitable approved conduit.

Before removing the shower heater cover, ensure the heater is isolated from the electric mains.

Quartz Electric is suitable for household use only.

### Flushing

Some modern fluxes can be extremely corrosive and, if left in contact, will attack the working parts of this unit. All soldering must be completed and the pipe work thoroughly flushed out in accordance with current Water Supply Regulations prior to connection of the product.

### Connections

Quartz Electric is suitable for use with 15mm British Standard pipe and should be connected using a 15mm compression fitting (not supplied). Quartz Electric is suitable for top, bottom or rear entry pipe work and top bottom or rear entry cable. Supply lines should be flushed clear of any debris prior to installation of the unit.

### Isolating valves

A suitable full bore isolation valve must be fitted to the incoming supply in accordance with the current Water Supply Regulations and our terms of warranty.

### Siting

The Quartz Electric unit must be mounted on a flat, vertical finished wall with the hose outlet pointing downwards. Any distortion of the back plate may result in the unit not working. Spacers are provided fitted to the service tunnel to enable the unit to be fitted to an uneven wall surface. DO NOT tile up to or use sealants around the Quartz Electric unit. The shower is spaced off the wall by integral pillars to allow air circulation around the unit.

The casing must not be sited where it is subjected to continuous spray from the shower head.

The Quartz Electric should not be sited in any situation where it is likely to freeze.

**I WARNING. DO NOT SWITCH THE SHOWER ON IF THERE IS A POSSIBILITY THAT THE SHOWER COULD BE FROZEN. If you have switched the shower on, SWITCH OFF IMMEDIATELY. Please refer to the trouble shooting guide overleaf.**

### Pressures

Check that the dynamic (running) water pressure to the Quartz Electric is adequate. A pressure test adaptor is provided, fitted to the inside of the front cover. Follow the pressure test adaptor fitting instructions opposite to ensure the water pressure to the shower is within the minimum and maximum requirements.

Quartz Electric requires:

Max: 1.0MPa (10 bar)

Min: 0.09MPa (0.9 bar) at a flow rate of 8 litres per minute

The Quartz Electric shower is designed to control static pressure up to 1.0MPa (10 bar). Where pressures are likely to exceed 1.0MPa (10 bar), a pressure reducing valve must be fitted into the incoming mains supply. A setting of 0.3MPa (3 bar) is recommended. It should be noted that daytime pressures approaching 8 bar can rise above the stated maximum overnight. A suitable pressure reducing valve is available from Aqualisa.

The use of other services connected to the water supply to the shower unit may cause the water pressure to drop below the minimum required. This should therefore be taken into consideration.

### Pressure relief device (PRD)

To meet European standards, the shower unit features an integral pressure relief device (PRD). The PRD provides a degree of shower unit protection should an excessive build up of pressure occur within the shower.

DO NOT operate the shower with a damaged or kinked hose or blocked shower head, as this can cause the PRD to operate. Failure to follow this instruction will invalidate the guarantee.

The shower will only function correctly with the hose and handset provided (see shower head installation instructions overleaf). Failure to do so may result in the operation of the PRD and will invalidate the guarantee.

Please fully commission the shower prior to use following the shower commissioning procedure detailed overleaf. Failure to do so could cause the PRD to operate and will invalidate the guarantee.

The shower unit must be sited over a bath or shower tray as in the event of the PRD operating, water will drain from the bottom of the shower unit.

### Inspection & maintenance

In the interests of safety, we recommend the Quartz Electric and its electrical installation are checked by a qualified electrician at least every 2 years.

Cleaning the filter should only be completed by a qualified person. Please refer to the instructions opposite of how to clean the filter.

### After installation

Familiarise the end user with the Quartz Electric operation and hand them this guide.

Complete and post the Quartz Electric guarantee card and optional guarantee extension agreement document.

### Declaration of Conformity

Aqualisa Products Limited declares that the Quartz electric shower, complies with the essential requirements and other relevant provisions of the Low Voltage Directive (2014/35/EU) and the EMC Directive (2014/30/EU).

## Trouble shooting guide

Symptom	Possible cause	Action
No flow or not enough flow	Power failure (light does not illuminate)	Check power supply, consult electrician
	Water control knob is turned fully clockwise.	Turn flow control knob anticlockwise.
	Water turned off at mains or servicing valve.	Ensure water is turned fully on at the mains and at servicing valve in supply.
	<b>SHOWER UNIT SUSPECTED OF BEING FROZEN.</b>	If so, DO NOT USE. i) Switch off immediately at electrical isolating switch. ii) Turn water off at servicing valve (if fitted) or at stop cock. iii) Contact our Customer Service Department.
	There may be an outlet blockage.	Disconnect handset from hose and run the shower. i) If water flows, then handset is blocked with scale or debris. Clean the handset and spray plate thoroughly. ii) If the water does not flow, remove the hose from the shower outlet. a) If the water flows, the hose is blocked. This could be due to damage, severe kinking or even an obstruction. Replace with a new hose. b) If the water does not flow, there is a blockage in the plumbing to the shower, the filter or the shower itself. Contact our Customer Service Department if the shower is considered to be the problem.
Blocked inlet filter		Remove the filter for inspection. PLEASE REFER TO INSPECTION AND MAINTENANCE SECTION
	Restricted operation of flow control knob	Remove front cover and check operation of knob
Flow adequate but water too cold	Water flow is too high	Reduce the flow by turning the water control knob towards the hot temperature markings (clockwise) slowly
	No power to unit	a) Check isolator switch is on b) Check MCB or fuse at consumer unit c) Check RCD (if fitted) d) Check 230/240V at terminal block (Electrician only)
	Second stage thermal trip operated	This is a non serviceable part, shower must be replaced
Water too hot	Water flow too low	a) Increase the flow by turning the water control knob towards the cold temperature markings (anticlockwise) slowly. b) Ensure that the stop cock and servicing valve are fully open. If so, ask the installer or the local water authority to check that the running pressure is above the minimum requirement (see Pressures section overleaf). This may be apparent during periods of high demand or when other outlets are used.
	Spray plate blocked with scale or debris.	Clean the handset spray plate.
	Water pressure too low.	Check with the installer or local water authority
Water runs from around hose	Pressure relief device (PRD) has operated due to excess pressure build up.	Turn off electrical isolating switch and water servicing valve and contact our Customer services department.
	Hose incorrectly fitted.	Ensure hose washer is fitted and hose is connected correctly and tightly
	Water pressure to shower is low or unstable	Check inlet requirements – see Pressures section, and ensure no other main water devices are being used while showering
	Thermal cut-out is operating, normally making a 'click' sound	Increase the flow by turning the water control knob in the cold temperature direction (anticlockwise). Clean the handset and spray plate.
Poor spray pattern	Scald protection device has activated	Increase the flow by turning the water control knob in the cold temperature direction (anticlockwise). Clean the handset and spray plate.
	Multi pattern handset incorrectly set	Adjust spray plate to improve pattern
	Low water inlet temperature	Flow rate will naturally be lower when the inlet temperature is low, this applies to all electric showers
	Low voltage	Consult electrician

## Cleaning & maintenance

Your Quartz Electric unit should be cleaned using only a soft cloth and washing up liquid.

**DO NOT USE ABRASIVE CLEANERS.**

To reduce the requirement for chemical descaling in hard water areas, the shower head incorporates rub clean teats. Any scale build up that may occur in any of the holes can be broken down by gently rubbing the flexible tips of the jets during use. This procedure should be completed regularly, as often as once a week in some hard water areas as scale build up can affect the spray pattern and cause the shower to perform poorly.

Should chemical descaling of the head become necessary, remove the shower head and fully immerse in a mild proprietary descaler.

**! IT IS IMPERATIVE THAT DESCALING IS CARRIED OUT STRICTLY IN ACCORDANCE WITH THE MANUFACTURERS INSTRUCTIONS. SUBSTANCES THAT ARE NOT SUITABLE FOR PLASTICS AND ELECTROPLATED SURFACES MUST NOT BE USED.**

### Cleaning the filter

Cleaning the filter should only be completed by a qualified person.

- Turn the shower electrical isolating switch off.
- Isolate the water supply to the shower.
- Carefully remove fixing screws from the top and bottom of the front cover. Carefully pull the front cover away from the unit ensuring the solenoid connector block is detached.
- Unscrew the two screws on the filter protective cover and remove the filter assembly. (Fig.2).
- Remove the filter assembly and clean as necessary. (Fig.3).
- Refit the filter assembly and protective cover. Reassemble the unit in reverse of the above procedure.

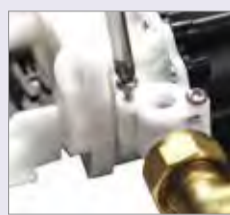

Fig.2

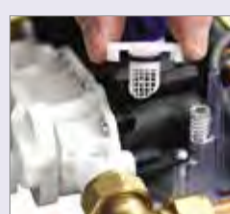

Fig.3

### Pressure test adaptor fitting instructions

Quartz Electric requires the following dynamic (running) water pressure:

Maximum: 1.0MPa (10bar)

Minimum: 0.09MPa (0.9bar) at a flow rate of 8lpm

To ensure the water pressure to the shower is adequate, we recommend adopting the following procedure:

- Isolate the electrical supply to the shower.
- Isolate the water supply to the shower.
- Remove the fixing screws from the top and bottom of the front cover. Carefully detach the solenoid connector and pull the front cover clear.
- Remove the pressure test adaptor from the inside of the front cover.
- Unscrew the two fixing screws on the filter and remove the filter assembly.
- Replace the filter assembly with the pressure test adaptor and secure into place using the filter assembly fixings.
- Connect a pressure testing device to the adaptor (not supplied).
- Ensuring the electrical supply remains isolated, turn on the water supply to the shower.
- Push the solenoid piston up until water runs through to the shower unit.
- Check the reading on the pressure testing device is within the minimum and maximum requirements stated above.
- Isolate the water supply to the shower.
- Detach the pressure test device and remove the adaptor.
- Refit the filter assembly and secure using the fixings.
- Refit the pressure test adaptor into the fixing position within the front cover.
- Reassemble the unit in reverse of the above procedure and turn on the water and electrical supplies to the shower unit.



Quartz Electric shower with adjustable height head in Satin chrome



Quartz Electric shower with adjustable height head in White/chrome



Quartz Electric shower with adjustable height head in Graphite/chrome

## Components



Literature not shown.

## AQUALISA

Aqualisa Products Limited  
The Flyers Way  
Westerham Kent TN16 1DE  
Customer Helpline: 01959 560010  
Brochure Hotline: 0800 652 3669  
Website: www.aqualisa.co.uk  
Email: enquiries@aqualisa.co.uk  
Republic of Ireland  
Sales enquiries: 01-864-3363  
Service enquiries: 01-844-3212

Please place product serial number label here.



Please note that calls may be recorded for training and quality purposes. The company reserves the right to alter, change or modify the product specifications without prior warning. <sup>®</sup> Trademark of Aqualisa Products Limited.

Part No: 438301 Issue 06 Oct20



### Pipe work installation

**!** In addition to the guide below it is essential that the written instructions overleaf are read and understood and that you have all the necessary components (shown overleaf) before commencing installation. Failure to install the product in accordance with these instructions may adversely affect the warranty terms and conditions. Do not undertake any part of this installation unless you are qualified to do so. Prior to starting, ensure that you are familiar with the necessary plumbing and electrical regulations and legislation required to install the product correctly and safely.

The Quartz Electric is supplied with universal fittings intended to secure the unit to a suitable wall.

Aqualisa reserves the right to revoke the terms of the warranty should access to service connections be denied by the use of solid setting infill material.

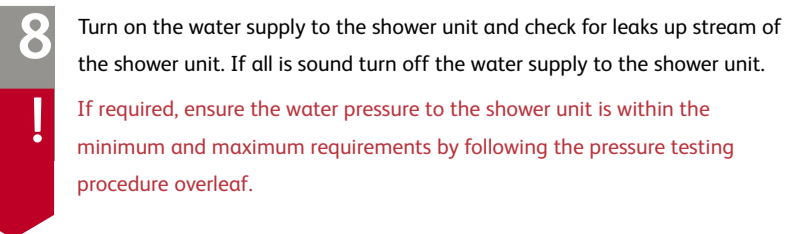
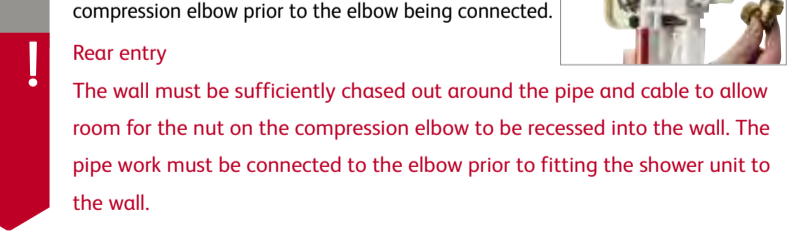
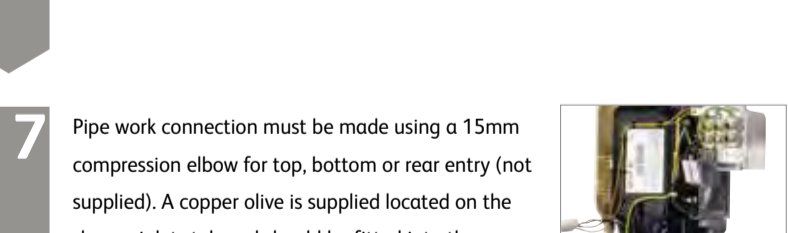
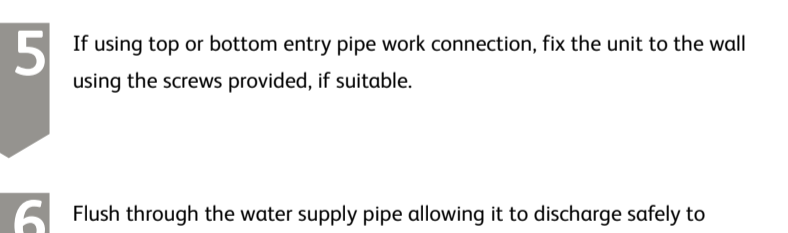
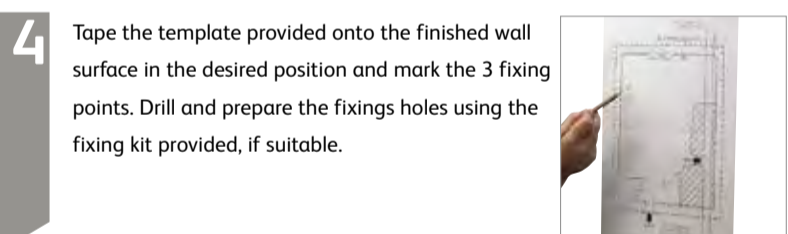
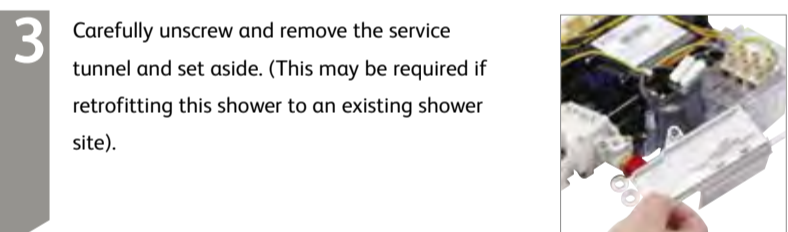
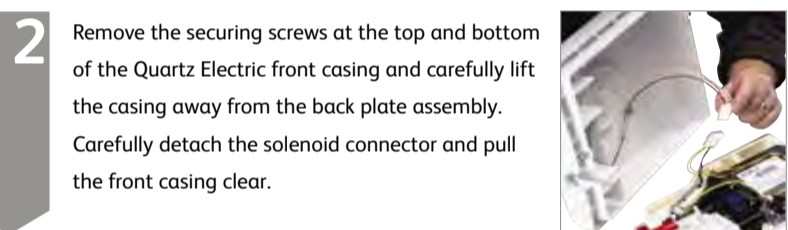
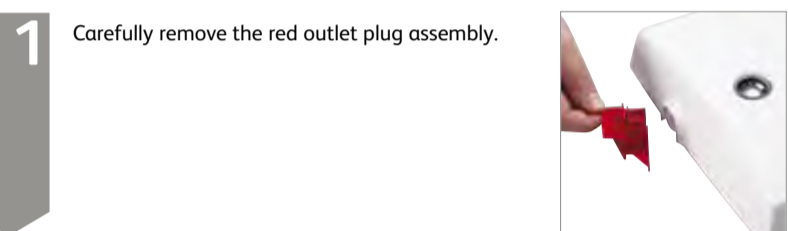

### Electrical installation

**!** BEFORE ANY ELECTRICAL CONNECTION IS ATTEMPTED, THE ELECTRICITY SUPPLY MUST BE TURNED OFF AT THE MAIN SWITCH. FAILURE TO DO SO COULD RESULT IN ELECTROCUTION.

The electrical installation should be carried out by a qualified person in accordance with IEE (Institution of Electrical Engineers) wiring regulations (BS 7671).

THIS APPLIANCE MUST BE EARTHED.

IN THE INTERESTS OF ELECTRICAL SAFETY, A 30mA RESIDUAL CURRENT DEVICE (RCD) MUST BE INSTALLED IN ALL UK 230-240V ELECTRIC SHOWERS AND PUMPED CIRCUITS. THIS MAY BE PART OF A CONSUMER UNIT OR A SEPARATE UNIT.

A suitably rated double-pole isolating switch for supply disconnection must be incorporated in the fixed wiring circuit in accordance with current wiring rules. This must have a mechanical indicator showing when the switch is in the OFF position. A neon lamp alone is not sufficient. (See the electrical rating chart for minimum switch rating). If it is fitted in the bathroom it must be the cord-operated type. The switch must be readily accessible and clearly identifiable in zone 3, i.e. at 0.6metres horizontally from the shower cubicle or edge of the bath, or located above zone 2 (i.e. adjacent to the shower cubicle or bath, but at least 2.25metres from the floor) as detailed below. This requirement does not apply to the pull cord from the switch.

Where shower cubicles are located in rooms other than bathrooms, any socket outlet in the room must be situated at least 3 metres from the shower cubicle and protected by 30mA RCD.

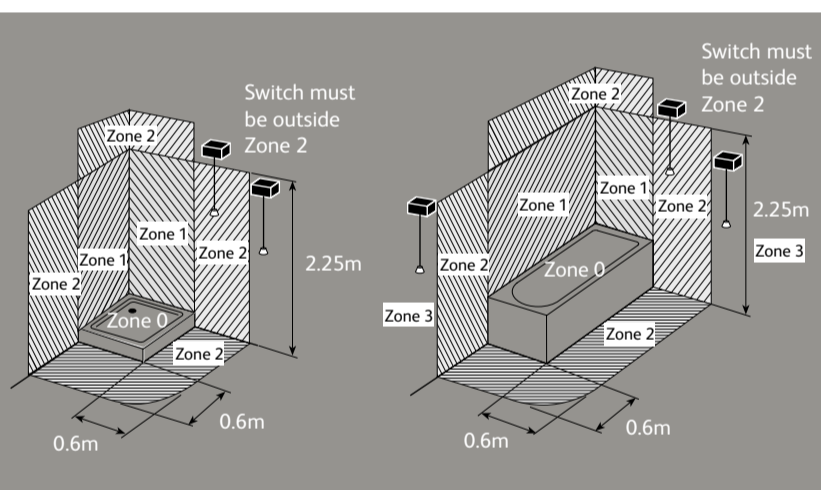

### Mains voltage connection

**!** Please refer to the typical system diagram opposite.

The following notes are for guidance only – the installation must comply with current regulations.

- 1 The shower unit must only be connected to a 230-240V ac supply.
- 2 Before making electrical connections within the installation make sure that no terminal is live. If in doubt, switch off the whole installation at the consumer unit or switch fuse (where fitted).
- 3 The shower unit must be connected to its own independent electrical circuit. It MUST NOT be connected to a ring main, spur, socket outlet or lighting circuit, otherwise the circuit will overheat.

- 4 Check that the consumer unit (main fuse box):  
A has a main switch rating of 80A or above and B has a spare fuse way which will take the fuse/mcb (miniature circuit breaker) you need to fit.  
If so you can wire the shower direct to the consumer unit (please refer to the typical system diagram below).  
(Not all consumer units accept a 35/40/45A sized fuse).

- 5 If the consumer unit has a rating below 80A or if there is no spare fuse way, then the installation will not be straightforward. It may be necessary to install a new consumer unit to service the whole house or just the shower. This should be installed by a qualified person. It may be necessary to contact the electricity supplier to upgrade the incoming supply.

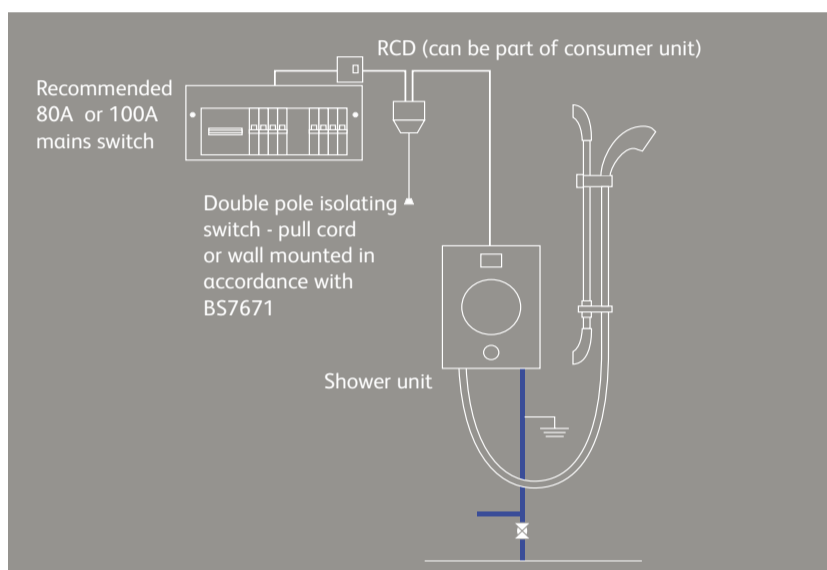

### Electrical rating

Refer to the electrical rating diagram (shown overleaf) to determine the nominal current of the shower. The current rating of the supply cable must be at least that of the shower itself. Use the rating chart to choose a fuse or mcb with a rating of less than that of your chosen cable.

**!** WE STRONGLY RECOMMEND NOT USING REWIRABLE FUSES.

The current rating will be reduced if the cable is to be:

- A. Bunched with others
- B. In an ambient temperature above 40°C
- C. In an insulating wall or within thermal insulation, e.g. loft insulation.
- D. In any other unusual position

If in doubt about any aspect of electrical installation, consult a qualified electrical engineer or the electricity supplier.

### Wiring installation

- 1 For most installations the removable service tunnel will not be required, enabling the earth connection to be made in the top right hand corner of the unit as illustrated.

**!** If retro-fitting the unit to an existing shower where the wiring cannot be connected as above, it may be necessary to utilise the service tunnel and alternative earth connection position.

- 2 Replace the service tunnel and secure using the fixing screw provided.

- 3 Unclip the earth terminal block and reposition it into the holder on the service tunnel.

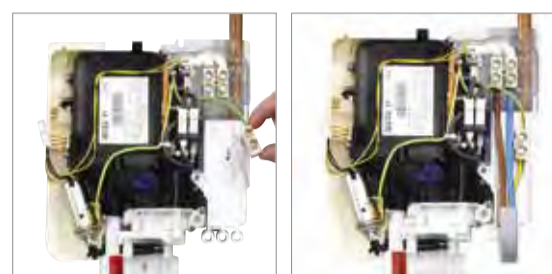

- 4 Any cable MUST NOT have the outer insulation stripped back beyond the bottom of back plate or service tunnel (if used) and must be protected from water as shown.

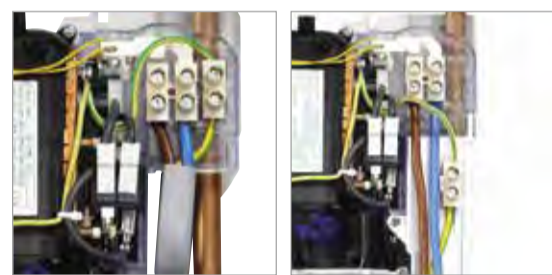

### Earth bonding

**!** The installation must be earth bonded in accordance with current regulations. Where earth bonding of the premises is not evident, it may be necessary to run bonding cable back to the earth terminal at the consumer unit.

### Shower head installation

The shower head should be sited close to the shower unit, not necessarily on the same wall, but not so that the unit is subjected to continuous spray. The shower head should be sited so that it is no more than 610mm (2ft) above the bottom of the unit or no lower than 305mm (1ft) below the unit, when in its normal position in the shower head holder.

**!** THE SHOWER OUTLET, HOSE AND HANDSET ACT AS A VENT. THEY MUST NOT BE BLOCKED, OBSTRUCTED OR HAVE CONNECTED TO THEM ANY FITTING NOT APPROVED BY US. THE USE OF UNAPPROVED ACCESSORIES MAY INVALIDATE THE GUARANTEE AND MAY AFFECT THE PERFORMANCE AND SAFETY OF THE UNIT.

- 1 Prepare two fixing points 465 – 470mm vertically apart using the fixings provided, if suitable.

- 2 Pass the rail through the handset holder whilst keeping the slider button depressed.



- 3 To comply with current water supply regulations, the handset should not be able to pass a point 25mm above the spill over level of the bath or tray. If this is not achieved, then the hose restraint/gel hanger must be used Slide this onto the rail under the handset holder.



- 4 Fit the rail into the rail end bodies taking care to engage the location slot onto the lugs.



- 5 Secure the rail assembly to wall using the fixings provided, if suitable, ensuring the rail and rail end bodies remain firmly engaged.

- 6 Place the rail end caps into the rail ends and push firmly into position.

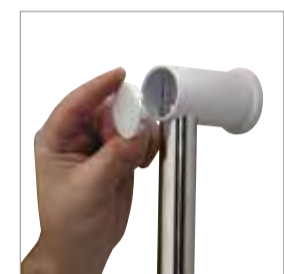

Please complete the commissioning procedure detailed below prior to connecting the handset and hose.

- 7 Ensuring the hose washers are in the correct position, depress the anti-swivel locking button on the handset and secure the handset to the hose. Place the handset into the handset holder.



**!** THE TENSION OF THE HANDSET STATION OF THE HANDSET HOLDER IS FACTORY SET. HOWEVER, IT MAY BE NECESSARY, TO TIGHTEN THE TENSION AS REQUIRED. TIGHTEN THE SCREW INSIDE THE HANDSET STATION TAKING CARE NOT TO OVER-TIGHTEN.



### Front cover preparation

When the pipe work and electrical connections have been completed the front cover can be prepared to be fitted prior to beginning the commissioning procedure.

- 1 Remove the relevant pipe work and cable entry point from the relevant section of the front cover if required, using a suitable tool. We recommend making good the cut out section using a round file. Ensure the cover fits over cables and pipe correctly.



- 2 Fix the self tapping screws a couple of turns into the fixing points at the top and bottom of the unit to aid locating the fixing points when securing the front casing to the back plate.



### Front cover installation and shower commissioning

**!** This shower must be fully commissioned following the procedure detailed below before use. Failure to do so could damage the shower and invalidate the guarantee.

- 1 Without fitting the shower head, fit the hose washer into the hose and attach to the shower outlet to allow the water to discharge safely to waste.



- 2 Ensuring the electric supply remains isolated turn on the water supplies. Push the solenoid piston up until water runs through and out of the hose for a few seconds before releasing the piston.



- 3 Attach the hose to the shower handset as detailed above after passing it through the hose restraint/gel hanger (if required) and place in the handset holder in a position where it can spray safely. Push the solenoid piston up until water sprays through the handset for a few seconds before releasing the piston.

- 4 Turn the flow control valve on the shower unit to the full cold (6 o'clock position). Turn the flow control lever on the front casing to the full cold position (9 o'clock). The flow control valve and lever are keyed and must be correctly positioned in order for the cover to fit.



- 5 Hold the cover next to the shower unit on the wall and carefully attach the two solenoid connectors. Place the solenoid connector block into the saddle within the shower unit and neatly tuck the wires into the recess provide.



- 6 With the self tapping screws partially fitted to the fixing locations in the front casing, carefully offer it onto the back plate assembly ensuring the wires are not trapped. The control knob, in the fully cold position, may have to be slightly adjusted to enable the keyways to align.



- 7 Secure the front cover to the base plate using the 3 fixing screws taking care not to overtighten.



- 8 Turn the flow control knob to ensure it moves smoothly. If not, the knob may be fitted incorrectly. The shower should be commissioned with the knob in the mid position (12 o'clock).

- 9 Turn on the electrical isolation switch. Press the start stop button and ensure the blue light surround illuminates.

- 10 Slowly turn the flow control knob towards the hot direction. The heater elements should now be hotter and the temperature of the spray should increase.

- 11 Adjust the flow control knob to provide the desired temperature. Allow a few seconds after each adjustment for the temperature to stabilise. A cool shower can be achieved with the flow control knob set towards the cold direction. The temperature achieved will depend on the incoming water temperature and pressure.

- 12 When the unit is fully commissioned please remove the red warning label from the front of the shower casing.

### User Instructions

#### To turn on and set the temperature

- 1 Turn on the isolating switch.
- 2 Press the start/stop button, the blue light ring should illuminate.
- 3 Rotate the control knob to give the desired temperature; clockwise for warmer and anticlockwise for cooler. Allow a few seconds after each adjustment for the temperature to stabilise.

**!** WARNING: ALWAYS CHECK THE SHOWERING TEMPERATURE BEFORE STEPPING INTO THE SHOWER. IT WILL TAKE APPROXIMATELY 20 SECONDS TO REACH A STABLE TEMPERATURE.

#### To turn the shower off

- 1 Press the start/stop button.
- 2 Turn off your isolating switch.

N.B. The phased shutdown feature of this shower requires the shower to run on for a few seconds after the shower is turned off. This is a safety feature which flushes any residual hot water out of the shower unit to protect the next user.

#### Shower head operation

**!** NEVER ATTEMPT TO MAKE ANY ADJUSTMENT TO THE SHOWER HEAD BY PULLING ON THE SHOWER HOSE.

- 1 To select the preferred height for the shower head, depress the handset holder button fully to enable the slider to be moved up or down the rail.

- 2 Angular adjustment is made by carefully but firmly pulling forwards or pushing back the shower head against the knuckle in the holder.

- 3 To select the desired spray pattern rotate the shower spray plate clockwise or anti-clockwise.