

Technical Datasheet



Product Code: 237CAS16PF

Product Description: Arley Cascade 1600mm No Tap Holes Premier Finish Single Ended Bath

Specification

Material:	Acrylic
Style:	Modern
Shape:	Rectangular
Number Of Tap Holes:	0
Overflow Included:	Yes
Waste Included:	No
Bath Thickness:	8 mm
Product Guarantee:	10 Years
Water Capacity (litres):	180



Key Features

- Sleek lines add an element of style to your bathroom
- Manufactured from high quality white acrylic
- Features heavily reinforced finish on underside of bath
- Finish provides exceptional strength & heat retention
- Ideal for free standing mixer use but can be drilled if needed
- Panels & wastes are available to purchase from Arley
- Available in 1500 & 1700mm with standard finish option

Technical Drawing

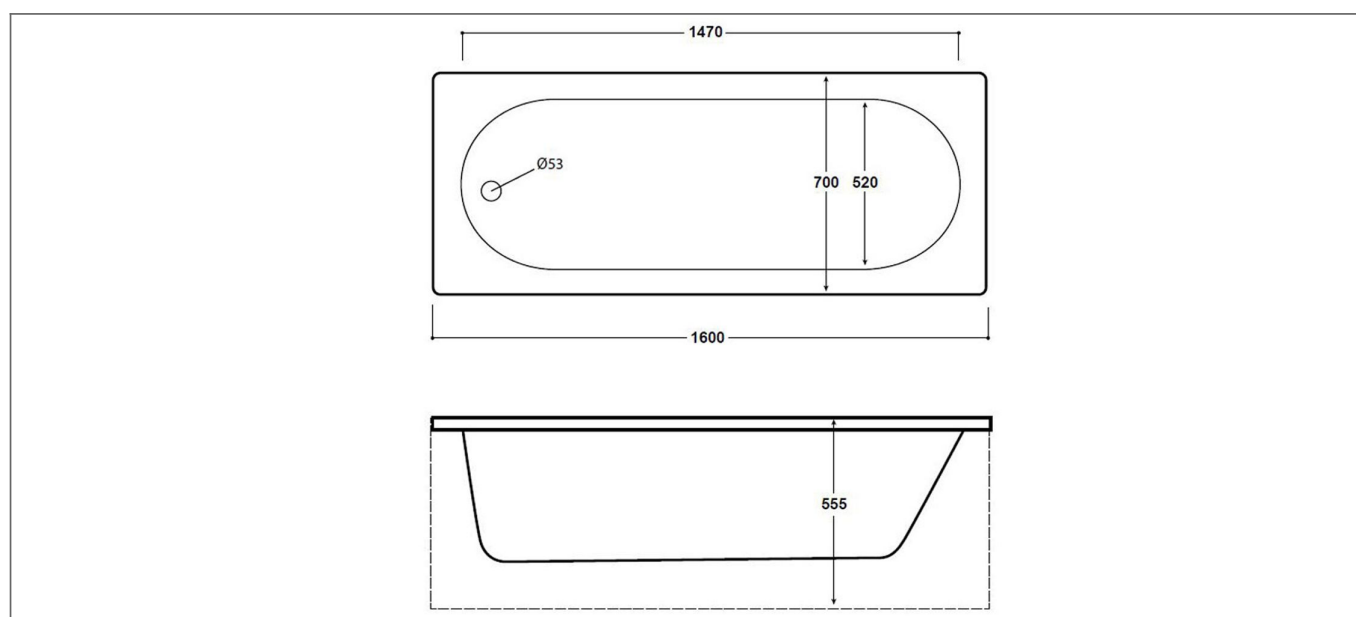

Dimensions: All measurements are in millimetres and are subject to normal manufacturing variations.

Due to a continuing development programme to improve design and performance, we reserve all rights to vary specifications without prior notice. Please note, all accessories are for photographic purposes only.