

MINI2 TS1203 EL C COMMERCIAL Shower Range

OPAC Thermostatic Exposed Mini Shower Valve with Lever Chrome



Specification

Finish/Colour:	Chrome Plated
Main Construction Material:	Brass
No of Controls:	1
Shower Type:	Exposed Mini Valve
Shower Head Type:	N/A
Shower Kit:	N/A
Valve/Cartridge Type:	Sequential Cartridge
Maximum Hot Water Supply Temperature °C:	65
Plumbing System Suitability:	Suitable for all plumbing systems, ideally balanced
Minimum Dynamic Pressure (bar):	0.1
Maximum Dynamic Pressure (bar):	5
Maximum Static Pressure (bar):	10
Connection Inlet:	15mm compression elbows
Connection Outlet:	1/2" BSP
Isolation Valve Included:	No
Check Valve Included:	Yes

Features:

- Single sequential control for both temperature and flow
- Adjustable inlet centres mean you can use existing pipework with centres between 110mm and 155mm
- High performance even at 0.5 bar inlet pressure
- Automatic shutoff in the event of hot or cold water supply failure
- Check valves and serviceable filters as standard
- OPAC Thermostatic TMV3 Mini Valve with Adjustable Elbows and Chrome Lever.

Product Certifications:



WRAS Certificate No: 240403011
WRAS Expiry Date: 30/04/2029



TMV2 Cert. No: NSF2126/0619
TMV2 Expiry Date: 13/12/2024



TMV3 Cert. No: NSF2125/0619
TMV3 Expiry Date: 13/12/2024

Dimensions (measurements in mm)

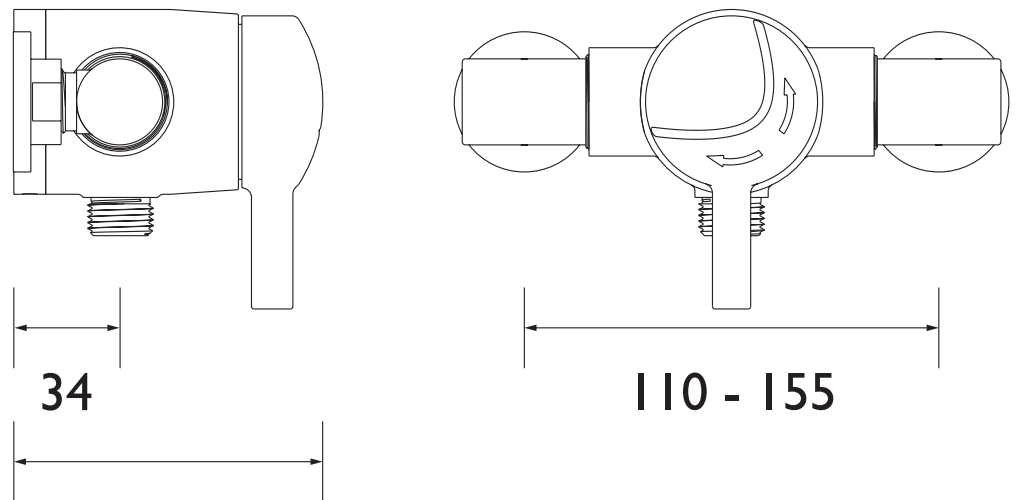

Flow Rates (l/min)

System Pressure (bar)	0.5	1	2	3	5
With Fitted Flow Limiters (mixed)	5.7	7.8	8.8	9.1	9.3

TECHNICAL DATA SHEET



BRISTAN

D14