



BRISTAN

Installation Instructions & User Guide

Please leave these instructions with the end user

Product Code: PNE EFSNK BLK (D2)

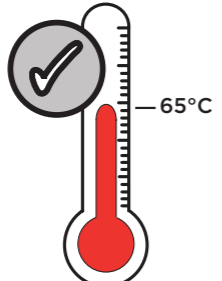
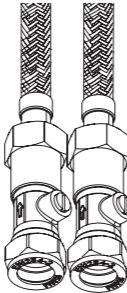
Specifications

<p>Dynamic Water Pressure Min: 0.3 bar Max: 5.0 bar</p>  <p>Maximum Static Pressure: 10.0 bar</p>	<p>Inlet Water Temperature</p>  <p>Maximum Hot 65°C</p>	<p>Inlet Connections</p> <p>1/2" BSP Flexible Tails with Isolation Valves</p> <p>Non-Return Valves Included</p> 	<p>Outlet</p>  <p>M21.5 Aerator</p>
---	---	--	---

Tools You'll Need

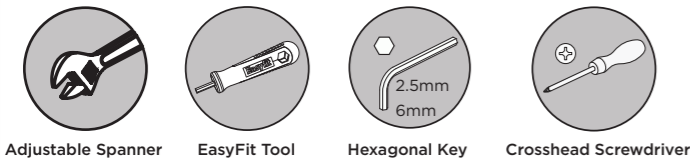

Spare Parts

To replace any spare parts for your tap, why not scan the QR Code or visit www.bristan.com and search for your product.



Prior to Installation

All products manufactured and supplied by Bristan are safe provided they are installed, used correctly and receive regular maintenance in accordance with these instructions.

This product has been tested to the Water Regulations Advisory Scheme (WRAS) and satisfies the requirements of the Water Supply (Water Fittings) Regulations 1999 and current bylaws. For full Installation Requirements & Notes (IRN) please visit wras.co.uk/directory.

Isolation valves must be fitted to the inlet water supplies to ensure ease of future maintenance.

Before installing these taps the water supply must be thoroughly flushed in order to remove any swarf, solder etc.

This product must not be modified in any way as this will invalidate the guarantee.

Flexible Connecting Pipes

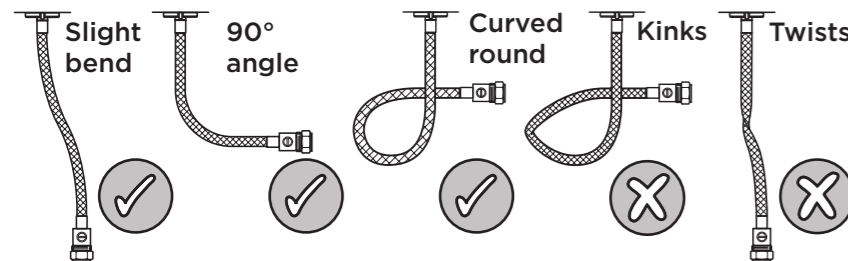

Pack Contents

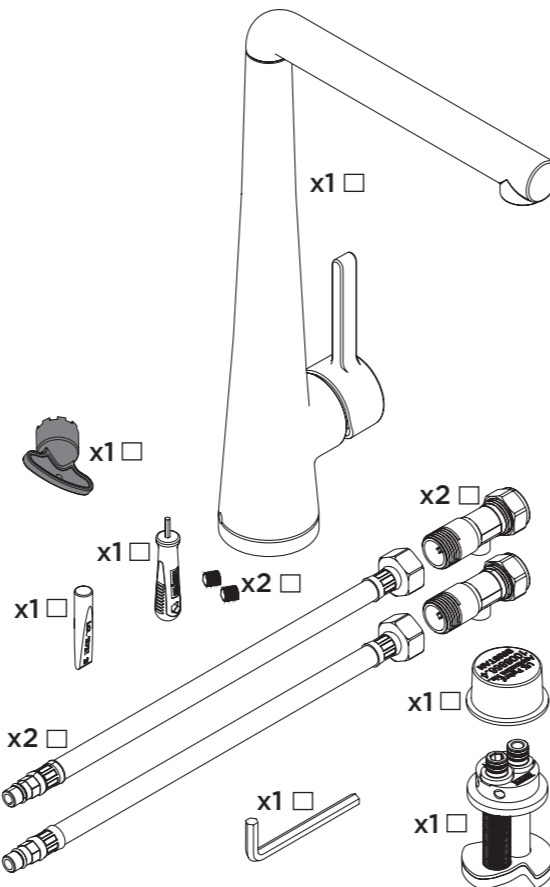

Installation

1 Remove the protective cap from the base assembly.

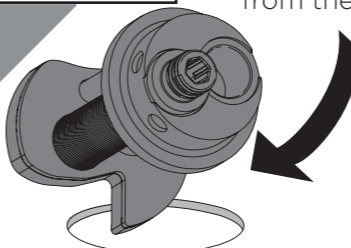

Feed the base through the sink hole from the top.

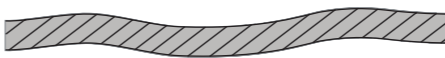

If the surface the tap is being fitted to is over 8mm; or you feel the tap needs extra stability, follow the **alternative installation steps** overleaf.

2 Drop the Plain Inlet Connector into the base.

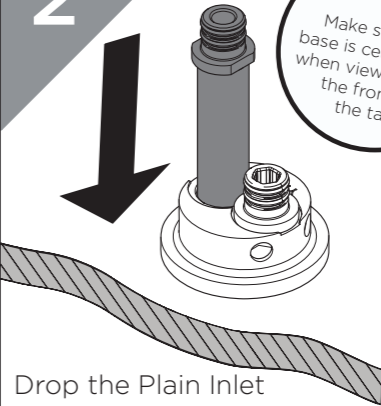

REMEMBER Make sure the base is centralised when viewed from the front of the tap.

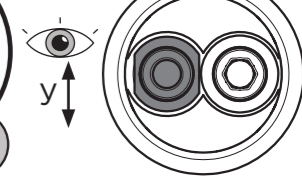

Ensure flat area of the plain inlet connector is sitting flush adjacent to threaded inlet connector.

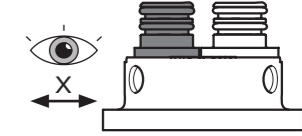

3 Turn the hexagonal key clockwise until the base is secured.



4 Screw the flexible tails into the base. **DO NOT OVER-TIGHTEN**. Hand tighten.

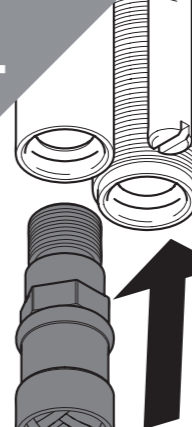

REMEMBER hot on the left, cold on the right.

5 Connect the hot and cold water connections.

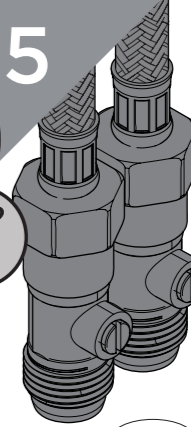

DO NOT OVER-TIGHTEN. Hand tighten.



Olive
Compression Nut

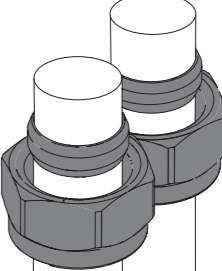

6 Grease the O-Rings using the Molykote Grease provided.

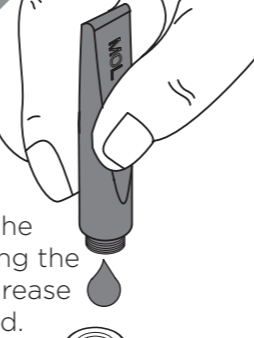

7 Place your desired tap onto the base.

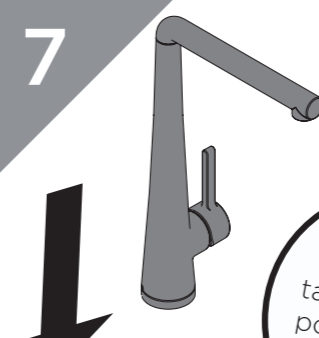

IMPORTANT Ensure the tap is correctly positioned and fully located on the base.

8 Secure in place with the grub screws using the tool provided.

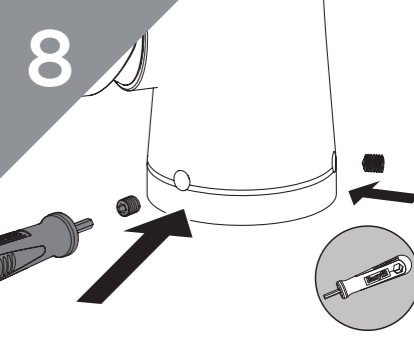

9 Thread the hexagonal key through the EasyFit tool and tighten the grub screws with an extra 1/2 turn.

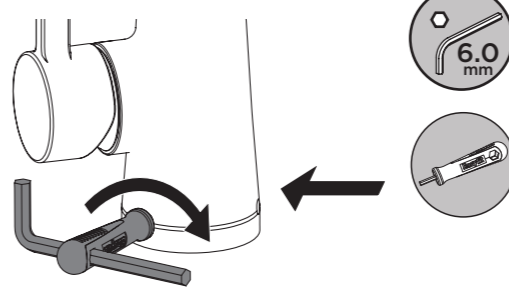

Your tap is now ready to use.

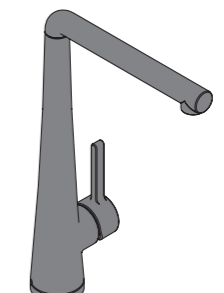

General Cleaning

Bristan products are made from premium materials, with hand polishing and electroplated finishes.

Your taps or shower should be regularly cleaned with warm water, a mild pH-neutral liquid soap, and polished with a soft cloth. Any residues from soap, toiletries etc. should be rinsed off straight after use.

Household bleaches and cleaners contain harsh chemicals and may damage the surface finish. Avoid using abrasive cloths, scouring pads, scrub sponges, steel wool or anything similar.

Some surfaces such as nickel and pewter may be affected by the dye found in some cloths, so it is also important to avoid hanging cloths on spouts.

Operation - Eco-Start

Starting temperature is cold. The temperature will gradually rise the further the rotation of the handle.

Once the handle ceases to turn, it will be **supplying the maximum temperature.**

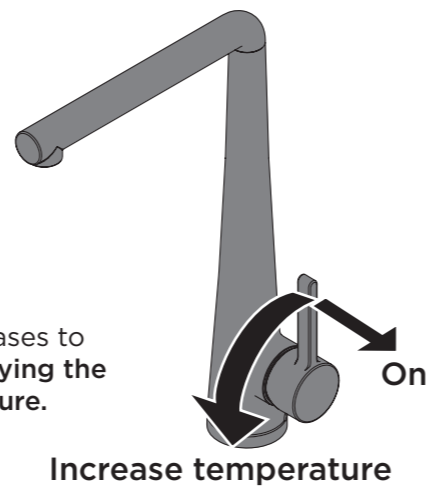

Maintenance - Cartridge Removal/ Replacement

1 **IMPORTANT**
Isolate the water supply before starting!

Remove the handle and shroud.

2 Unscrew the retaining nut and remove cartridge.

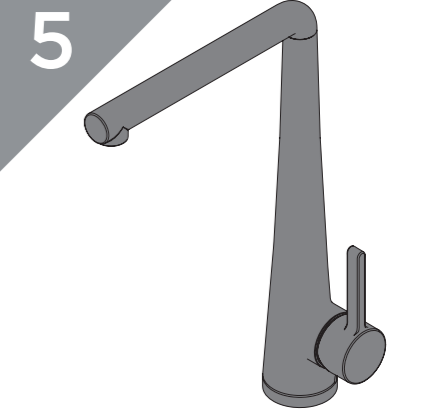

3 Scan the QR Code and search for your product code to replace the cartridge for your tap.



4 Reverse the steps to replace the valves and handles.

Turn on the mains water supply, letting the water flow for a few minutes to flush through the system.

Alternative Installation for Surfaces Out of Tolerance/Extra Stability

1 Turn the hexagonal key anti-clockwise to remove the back nut from the EasyFit Base.

2 Feed the base through the sink hole from the top.

REMEMBER
Make sure the base is centralised when viewed from the front of the tap.

3 Feed the Reinforcing Plate (if required) and Back nut up to the underside of the sink.

4 Turn the hexagonal key clockwise to secure the EasyFit Base.

5 Proceed to Step 4 of the Installation Steps.

Troubleshooting

Symptom	Cause(s)	Remedy
No flow or low flow rate	Partially closed isolation valve.	Open isolation valve.
	Head of water is below the minimum distance required.	Refer to your specification for the minimum working pressure/ distance required
	Hot or cold water being drawn off elsewhere causing pressure changes or instantaneous boiler temperature changes.	Do not use other water outlets when using the taps.
	Airlock or partial blockage in the supply pipework or hoses.	Flush through pipework to ensure removal of debris and any airlocks.
	Water supply failure	Investigate water supply. Check your plumbing and heating systems for any faults.
Water dripping from taps	This is normal for a short time after using the taps.	This is caused by residual water tension, the build up of water in the tap body.
	If water continues to drip, possibly due to the ceramic disc valves/cartridge	Refer to the Maintenance section to replace the valves/ cartridge.
Taps do not turn on	Closed isolation valve.	Open isolation valve.
	Mains water supply turned off.	Turn on mains water supply.

Contact Us

Bristan Group Ltd.

UK: Bristan Group, B78 1SG.
EU: Masco Europe S.à.r.l.
14 Rue Strachen
6933 Mensdorf
Luxembourg

BRISTAN

Customer Service: +44330 026 6273

Web: www.bristan.com
Email: enquire@bristan.com

A Masco Company

Maintenance - Cleaning/Replacing Outlet

1 Unscrew the aerator using M21.5 outlet key.

2 Remove the aerator from the spout. Clean and replace as necessary.

3 Secure the aerator. Turn on the mains water supply, letting the water flow for a few minutes to flush through the system.

At Bristan, we want to make things as easy as possible for our customers. That's why we offer solid guarantees on all our products, effective from the date of purchase, to give you peace of mind.

To start your free guarantee simply scan the QR code and register your product. Alternatively visit www.bristan.com/register.

For any other queries, please call our Customer Service on 0330 026 6273 where our expert team of advisors will be able to offer you any help and advice.

For full guarantee terms and conditions visit www.bristan.com/guarantees.

