

AXIS

L 1700MM
W 700MM

	5MM	CARRONITE
AXIS	✓	✓
L-SHAPED PANEL 1700x700x430	-	✓
FRONT PANEL 1700x430	✓	✓
END PANEL 700x430	✓	✓
SCREEN CFS-1 (H=1400MM)	✓	✓
SCREEN CFS-2 (H=1500MM)	✓	✓
GRIPS CCG-2	✓	✓

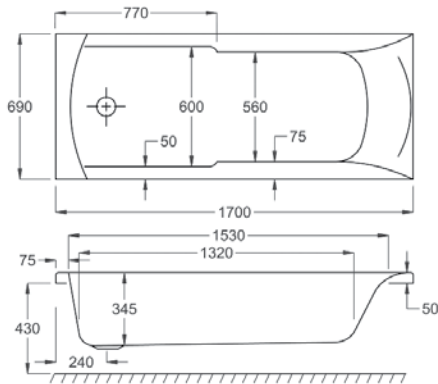

Carronite Panel



Hand Grips



Ease of Access



Water Saver

WATER CAPACITY

145 LTR

This measurement is taken to the overflow

WHIRLPOOL COMPATIBLE

N/A

KIT REFERENCES

STANDARD - AK-01

CARRONITE - AK-01-C