



Profile

Profile Deck Mounted Bath Filler - Gold

Product Code: DCM108/501

Finish: Gold

Features

- Construction:** Brass
- Valve/Cartridge type:** Standard
- Supply:** Suitable For Low Pressure Systems
- Working Pressures:** 0.1 - 5.0 bar
- Inlet connections:** 3/4" BSP
- Flexi or Copper:** N/A

· Optimised for bath filling



*Please refer to website for full warranty details.

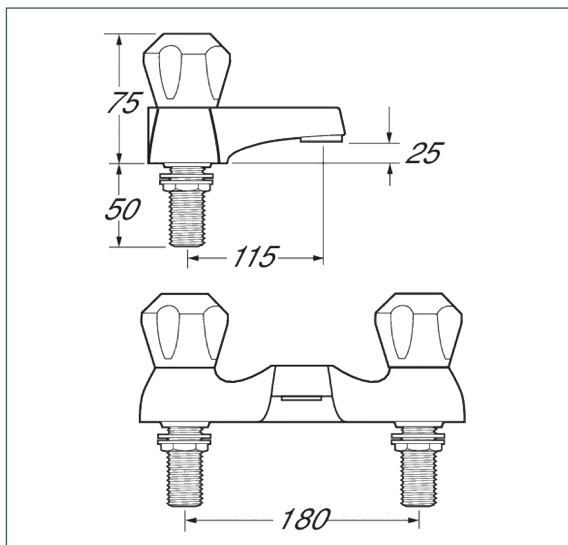

Flow (Bar - l/min, open outlet)

Spout

Flow 0.1	Flow 0.3	Flow 0.5	Flow 1.0	Flow 2.0	Flow 3.0	Flow 4.0	Flow 5.0
14.8	23.4	31.4	46.1	66.8	82.3	93.9	103.3



2408801

