

Warranty Information

Proof of purchase will be required.

The guarantee does not cover faults or damage caused by incorrect installation and/or maintenance, ordinary wear and tear, water composition, etc.

*Please see www.methven.com for full terms and conditions of warranty

Cleaning

Your product has a high-quality finish and should be treated with care to preserve the visible surfaces. Never use abrasives or abrasive cleaning agents to clean this product clean regularly with contamination free warm water and a damp soft cloth. Do not use products containing chlorine bleach or hydrochloric acid as these can damage the product.

We have a policy of continuous improvement and reserve the right to change specifications without notice.

METHVEN UK LIMITED
METHVEN EXPERIENCE CENTRE
3/3A STONE CROSS COURT
YEW TREE WAY
GOLBORNE
WARRINGTON
WA3 3JD
UNITED KINGDOM
INST-EKITO8/KH-V1

TEL: 0800 195 1602
FAX: 0844 406 8690
EMAIL: sales@uk.methven.com
www.methven.com

KAHA CHROME EASY FIT SHOWER KIT

EKITO8/KH Installation Guide

Technical Specification

Operating Pressure

Min: 0.3 Bar

Max: 5.0 Bar

Operating Temperature

Hot: 65°C

Cold: 5°C

Inlet Connections

1/2" BSP

Flow Regulated

8 Litres per Minute



METHVEN
www.methven.com EST 1886

Please read all of the instructions before installation.

General

Methven recommends this product is installed by a competent person in compliance with all relevant regional regulations.

After installation all connections must be checked for leaks.

All outlets used primarily for personal hygiene shall deliver water at a safe temperature as per regional regulations.

It is the responsibility of the installer to ensure a waterproof seal is achieved.

Flow Regulation

The handset comes complete with a flow regulator inserted into the inlet.

*Subject to change, based on the specification

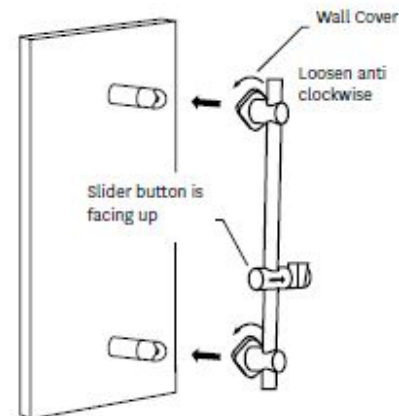
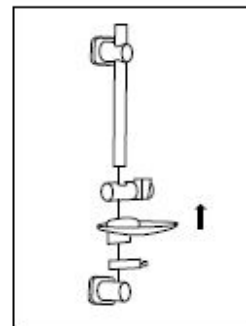
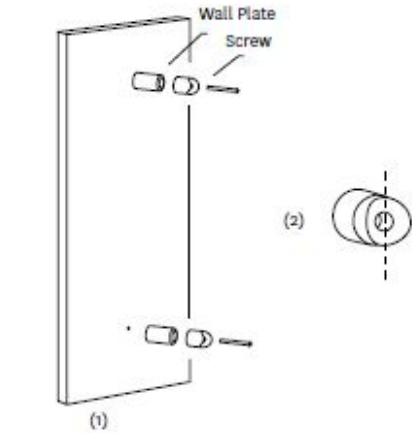

Installation Instructions

1) Use a 6mm drill bit to drill a hole in the wall at the desired height, drill a second hole vertically lower at a recommended height of 550mm. In certain situations, the hole may need to be further away to a maximum of 615mm. Place wall plugs into hole and push firmly into place. Place fixing bracket over the wall plugs (1) and insert screw provided, tighten until secure, repeat for second fixing bracket. Push rubber grip into fixing bracket aligning the groove vertically (2)

2) Assemble the handset slider, soap dish and hose retainer on to the rail ensuring button is facing upward. Attach both rail end assemblies.

3) Ensuring the handset slider button is facing upwards as shown in the illustration, adjust the two rail end assemblies to match the position of the wall brackets and turn wall covers anticlockwise to the unlock position.

4) Gently press the rail end assemblies onto the wall brackets, until the rail ends touch the wall. Turn both wall covers clockwise into the locking position, securing the rail. Adjust handset slider to desired height for showing.

5) Insert flat washer into the shower hose before screwing to the handset. Connect the other end of the shower to the shower outlet.

Place the handset securely into the handset slider, and turn shower mixer into the on position and check for leaks.

