

Sales Code: TIW453

Description: Industrial Deck Mounted Bath Filler

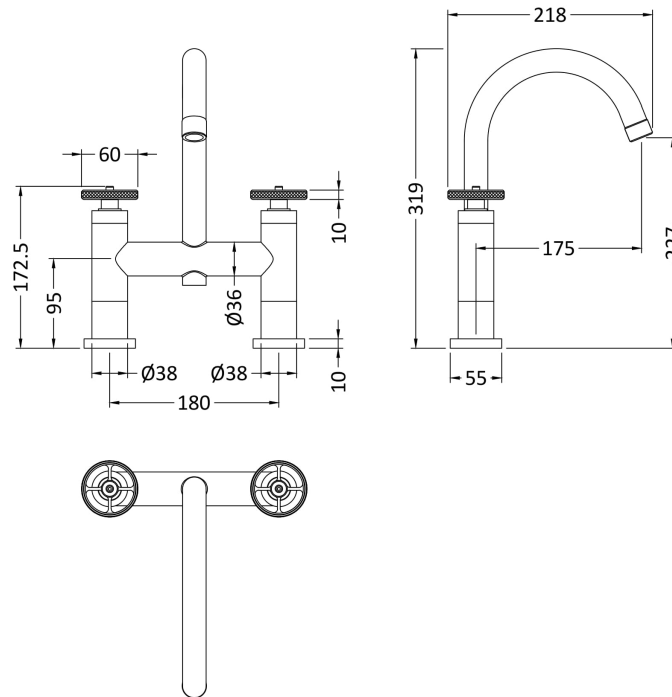

Product Dimensions

Height (mm):	319
Width (mm):	230
Depth (mm):	50
Length (mm):	
Nett Weight (kg):	3

Packaging Dimensions

Height (mm):	100
Width (mm):	235
Depth (mm):	265
Gross Weight (kg):	3.1

Packaging Data

Box Colour:	White Cardboard Box
Box Qty:	0
Label Size:	0 x 0
Label Colour:	White Label
Label Qty:	0

Outer Box Dimensions (If Applicable)

Height (mm):	320
Width (mm):	495
Depth (mm):	295
Length (mm):	
Gross Weight (kg):	19
Barcode:	5056462673738

Product Details

Country of Origin:	United Kingdom
Fitting Instruction:	No
Product Material:	Brass
Control Type:	Manual
Waste Included:	Waste Not Included
Waste Type:	Not Applicable
WRAS Approval: Yes	Approval No: 2204060
Valve/Cartridge Type:	1/4 Turn Ceramic Disc
Colour/Finish:	Matt Black
Mount Type:	Deck
Operating Pressure (bar):	0.2
Flow Rates: (Litres Per Min)	0.1 bar: 8 0.5 bar: 29 1 bar: 40 2 bar: 48 3 bar: 0
Pipe Size:	22 mm (3/4" Bsp)
Pipe Centres:	180 mm