



# CONCEPT/CONNECT AIR/ALCHEMY ACRYLIC SHOWER BATH

## Installation Instructions

**Please pass on to user**

# CONCEPT/CONNECT AIR ACRYLIC SHOWER BATH

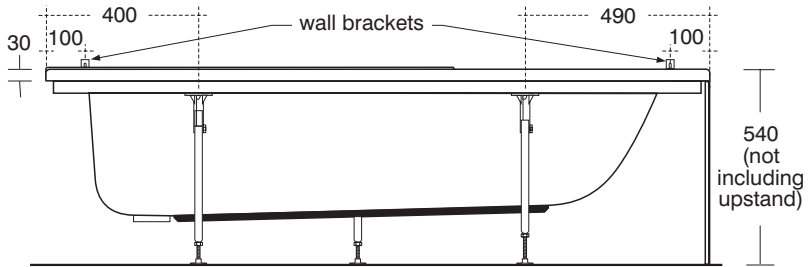
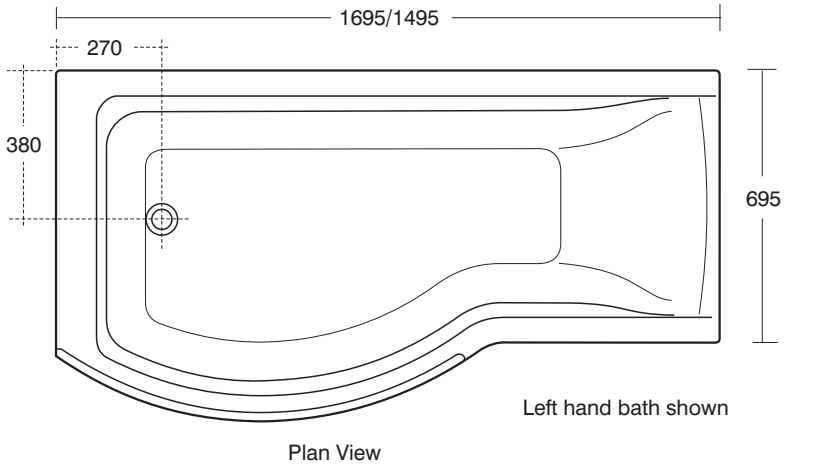

All dimensions shown in millimetres.  
Dimensions shown may vary within permitted tolerances.

**Fig. 1**

# CONCEPT/CONNECT AIR ACRYLIC SHOWER BATH











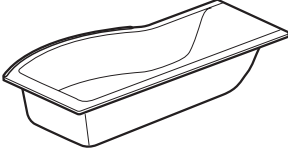







Ref.	Description		Qty.
A	Bath Tub		1
B	Bath Legs		2
C	Centre Support Bracket		1
D	Short Bath Foot		1
E	Bath Feet		4
F	Plastic Leg Adjuster		4
G	Bath Feet Locking Nuts		10
H	No. 8 x 12 Pan Head Self Tapping Screw		4
J	No. 8 x 16 Countersunk Woodscrew		2
K	No. 8 x 20 Pan Head Self Tapping Screw		10
L	No. 8 x 30 Countersunk Woodscrew		4
M	Wall Bracket		2
N	Single Support Leg		1

Fig. 2

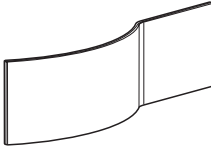
# CONCEPT/CONNECT AIR ACRYLIC SHOWER BATH

Front Panel		
Ref.	Description	Qty.
S	Panel 	1
T	Panel Clip 	4
V	Plastic Panel Clip 	5
W	No. 8 x 20 Pan Head Self Tapping Screw 	8
X	Screw and Cover Caps 	5

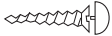
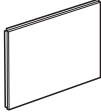
End Panel		
Ref.	Description	Qty.
AA	Panel 	1
Y	Panel Clip 	2
Z	No.6 x 12 Pan Head Self Tapping Screw 	2

**Fig. 3**

# CONCEPT/CONNECT AIR ACRYLIC SHOWER BATH

## BATH CONDITION

Before commencing installation, carefully remove packaging/protective film and check for damage. If damaged, report immediately to supplier.  
The bath should be fully protected during the installation process.

***Appropriate safety equipment/workwear should be used***

## INSTALLATION

1. Lay bath face down and remove legs and bags containing feet etc.

***The 4 black - No. 8 x 40 long countersunk crosshead self tapping screws retaining the legs are NOT REQUIRED and should be discarded..***

2. Locate leg adjusters, (Ref.F) on bath frame and mark positions for the fixing screws. See Figure 1 for dimensions.  
Pilot drill the holes ( $\varnothing$  2mm) in the bath frame and fix leg adjusters to frame, use screws (Ref. K).
3. Locate bath legs in leg adjusters ensuring that the orientation of the large leg is correct and mark positions for the fixing screws on the base board. Pilot drill the holes ( $\varnothing$  2mm) in the base board, to a depth of 6mm maximum. Position legs in leg adjusters and on base board and secure.  
Use countersunk screws, (Ref. L) into the baseboard and pan head screws, (Ref H) into the leg adjusters.

### **DO NOT OVER TIGHTEN.**

4. Locate centre support bracket towards the centre of the baseboard, mark screw hole positions, pilot drill holes ( $\varnothing$  2mm) in base board to a depth of 6mm maximum and secure bracket, use screws (Ref. J).  
Fit the single support leg black end cap onto relevant block (Fig. 5) using the supplied screw.
5. Fit panel clips to panel clip blocks.  
The panel clips (Ref. T) must be located onto the wooden blocks with the pan head screws supplied (Ref. W ), 29mm back from the edge of the bath rim.
6. Fit the feet and adjust to give approximate floor to top of rim height required.
7. Turn bath over and drill for brassware if required. If the bath is to be installed with a monoblock mixer a special hole (or holes) is required to accommodate the mixer and will have to be cut by the installer in an appropriate position on the rim of a no tap hole bath to suit the bathroom layout. Full details or a template for cutting the hole (or holes) is supplied with monoblock fittings. A template for cutting two tap holes in a no tap hole bath is supplied with the bath.

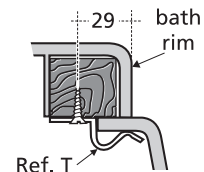

**Fig. 4**

# CONCEPT/CONNECT AIR ACRYLIC SHOWER BATH

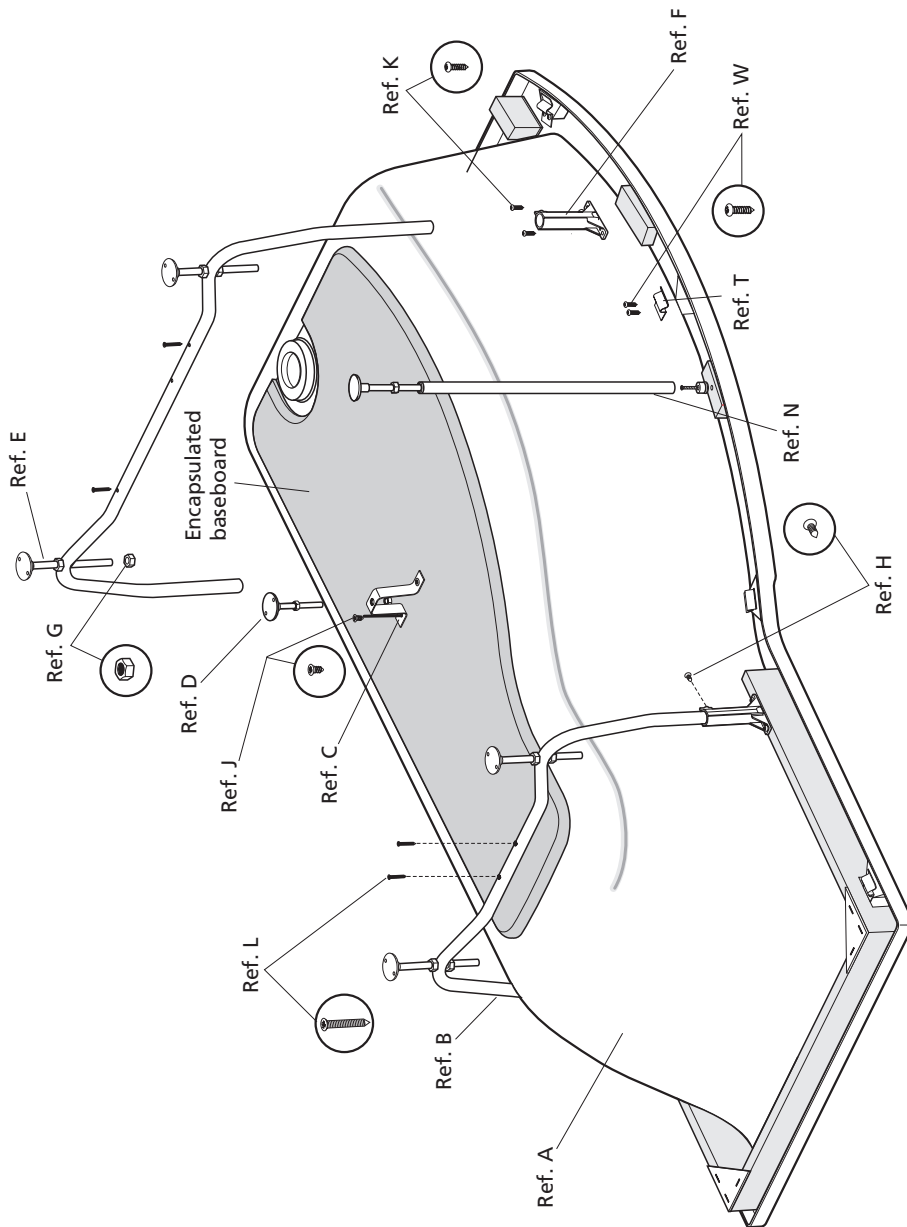
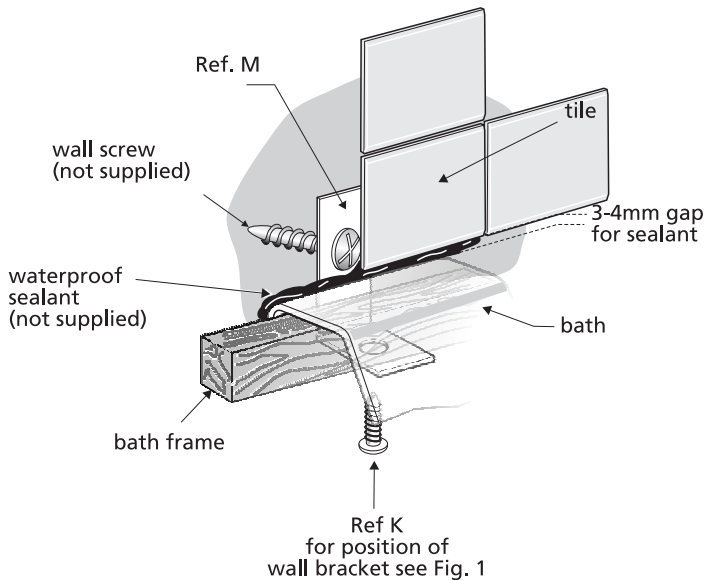

Fig. 5

# CONCEPT/CONNECT AIR ACRYLIC SHOWER BATH

8. Fit the two wall fixing brackets to bath frame as indicated in Fig. 6 and Fig. 1. Pilot drill holes ( $\varnothing$  2mm) in frame before fixing brackets.
9. Fit brassware.
10. Place bath into installation position and level bath, ensuring that the bath height is correct, (510mm to trimmed edge for nominal height). Note: The bath can be installed at a lower height, but this will reduce the space available for the waste to be fitted. Also, the panel(s) will need to be reduced in height by cutting a strip from the bottom edge. Reducing the panel height requires great care, therefore responsibility cannot be accepted for any errors made.
11. Fix bath to wall.
12. Fix bath to floor and ensure that all nuts are tight. Trial fit the panel(s) to verify height is correct. Note: Untrimmed panel fitment requires the height of 540mm (510mm to trimmed edge of bath). Remember to allow for floor coverings. Re-adjust if necessary. Fit the single support leg to the black cap previously fastened. Ensure that the leg is adjusted correctly to support the rim, but not forcing the rim upwards.
13. Connect services and check for leaks.
14. Tile down to the height of the bath rim leaving a 3-4mm gap for waterproof sealant, see Fig. 6. An extruded sealing strip can be used for the bath to wall joint as an alternative to waterproof sealant. Protect bath during tiling.



**Fig. 6**

# CONCEPT/CONNECT AIR ACRYLIC SHOWER BATH

## Fixing the bath panel

15. Pre fit front panel ensuring that the ends of the panel are vertical. Mark a line along the front of the panel on the floor. Remove panel and fix the plastic panel clips (Ref. T) onto the floor/wall(s) (Figure 7). The front of the block at the floor should be 3mm back from the marked line.

**Note:** The front panel may touch the support leg foot, (Ref. N), depending on its position. Remedy this by removing a small amount of material from the panel return.

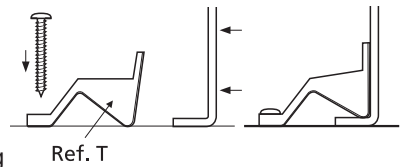

**Fig. 7**

16. Fit the end panel by using a wooden batten along the floor for support and engaging the top of the panel in front of the spring clips, (Ref. Y) secured with screws (Ref. Z).

17. Fit front bath panel in position and press the edges into the panel clips until fully engaged.

**Note:** Fit end panel before front panel. If the front panel does not easily insert under the panel clips, then release the screws by a quarter of a turn and retry.

**Note:** if the front panel has had the returns trimmed off, then the plastic panel clips will not grip the panel base. In this instance, use wooden blocks (not supplied) to secure the panel to the floor/wall. Screws with cover caps are supplied for this method of fixing.

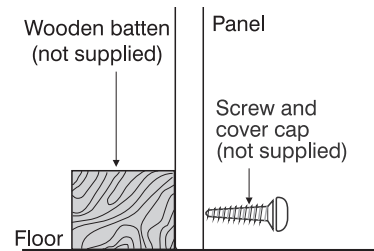

**Fig. 8**



# CONCEPT/CONNECT AIR ACRYLIC SHOWER BATH

---

## CARE OF BATH

This bath left our works in first class condition and the following points should be noted;

***TO AVOID DISAPPOINTMENT, PLEASE REMOVE THE PROTECTIVE FILM AND INSPECT BEFORE INSTALLATION.***

Responsibility will not be accepted for the installation of faulty baths.

### **Care of bath - for the installer:**

Keep under cover in a clean, dry, weather-proof place.

Do not drop. Protect completely during and after installation (with clean felt etc.).

**When making joint to waste, overflow etc. on this product, DO NOT use linseed oil putty or similar based sealing compounds. Ensure rubber washers supplied with waste fittings are located correctly to give watertight seal.**

Test the fittings and then do not use the bath for any other purpose.

**Please leave this leaflet for the end user to read.**

## WARNING

- 1. Filling.** It is advisable always to run in some cold water before turning on the hot tap.
- 2. Cleaning.** The bath should always be cleaned immediately after use, preferably whilst the water is running out and the bath is still warm. The film of insoluble soap products, body fats and grime which will otherwise harden on the side of the bath is easily removed at this stage. In hard water districts insoluble lime salts are deposited below the waterline and under leaking taps. If this deposit is allowed to build up, it becomes increasingly difficult to remove and looks unsightly. Prompt cleaning is again the answer. Hot soapy water with a cloth should be used and the bath wiped dry.
- 3. Cleaners of a gritty or abrasive nature should never be used.** Worn washers on dripping taps should be replaced.
- 4. Chemicals.** Acrylic has good resistance properties to acids and alkalis but should not be allowed to come into contact with organic solvents such as dry cleaning agents and paint strippers.
- 5. Removal of scratches.** In the event of slight scratches in the bath surface a mild abrasive, similar to metal polish, can be used to polish these out.
- 6. Burning cigarettes** should not be allowed to come into contact with the surface of this bath or damage may ensue.

# CONCEPT/CONNECT AIR ACRYLIC SHOWER BATH

## **Product Guarantee**

**2 5 Y E A R S**

**Idealform Acrylic baths**

**1 0 Y E A R S**

**Shower enclosures and bath screens**

**5 Y E A R S**

**Valves and kits, bath panels  
taps and mixers**

This covers products in domestic use by the consumer and not commercial or business use.

All Ideal Standard products must be installed, used and cared for in line with our fixing instructions, local water byelaws and current water regulations.

Access should always be left for installation, service and repair.  
Any relating costs are the responsibility of the owner/installer.

Guaranteed parts will be replaced if found faulty.

This guarantee does not cover general wear and tear.

Applies to the UK and Republic of Ireland only.

Proof of purchase will be required for any warranty claim.

# CONCEPT/CONNECT AIR ACRYLIC SHOWER BATH

---

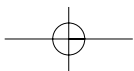
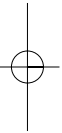
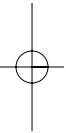

# CONCEPT/CONNECT AIR ACRYLIC SHOWER BATH

---



Ideal Standard

The Bathroom Works  
National Avenue  
Kingston upon Hull  
HU5 4HS England  
Telephone: (01482) 346461  
Telefax: (01482) 445886.

## **CUSTOMER CARE HELPLINE**

**0870 1296085**

**CUSTOMER CARE FAX LINE 01482 499611**  
**email: [ukcustcare@IdealStandard.com](mailto:ukcustcare@IdealStandard.com)**

We pursue a policy of continuing improvement in design and performance of our products. The right is, therefore, reserved to vary specifications without notice.

Ideal Standard (UK) Ltd.

4994 10/20  
**EE74200967**