



Ideal Standard

Simplicity Shower Tray

Installation Instructions

Before you Start

- Please note that although these instructions are comprehensive we always recommend that a technically competent installer undertakes the installation.
- **WARNING! Your shower tray may be heavy and to avoid injury should always be considered a two person lift.**
- **Caution:** Care should be taken when drilling into walls or floors to avoid hidden pipes or electrical cables.
- When handling your shower tray take care not to damage the bottom edges and when installing take particular care to protect the visible surfaces from impact damage or abrasions.
- Check that the shower tray is the colour, size, shape and type you require.
- Unpack and check for any damage. Do not install if not satisfied and contact your local supplier.
- Check that the top surface of the shower tray is compatible with your intended shower enclosure, taking into account the reduced area that will result after tiles etc have been fitted. This is very important if using a shower tray with a tiling upstand.
- If you install this shower tray in conjunction with a steam unit, you must ensure that the steam outlet is a minimum of 350mm from the top of the tray.
- When considering your installation method, you should be able to attach or repair your waste or waste outlet in situ.

Additional notes if installing with a Riser Kit

- For shower trays with one or more dimensions longer than 1200mm and up to 1700mm in length an extension panel kit is required.
- Check the pack and ensure you have all of the parts listed and that this kit is compatible with your chosen shower tray.
- Before cutting any panels, ensure that your chosen shower tray is compatible with the dimensions of the tray after tiling. This is especially important if a shower tray incorporating a built in tiling upstand is being used or if electing to recess the edge of the tray into adjacent walls.
- **Note:** If in doubt contact your supplier who will be able to help you

Installation Options

Option 1

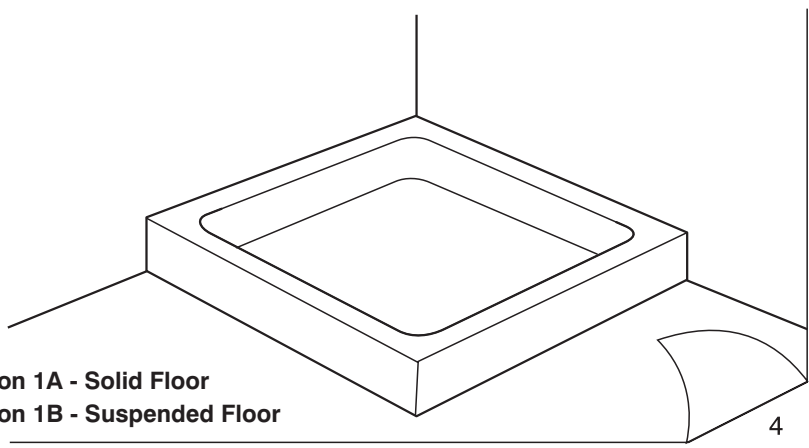

Option 2

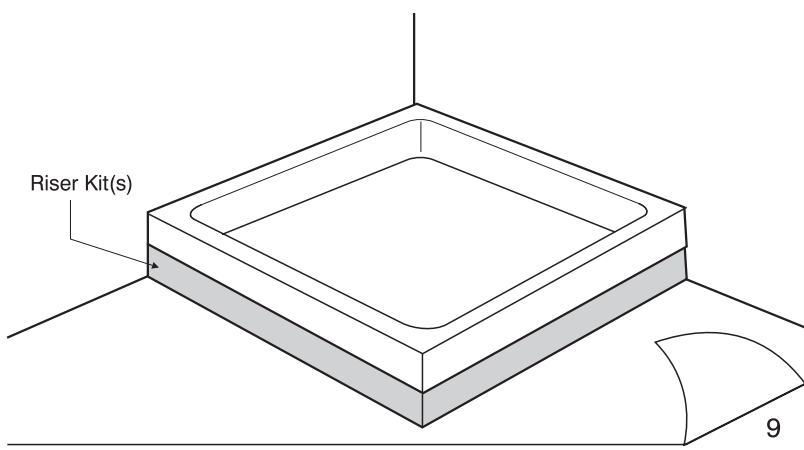

Installation Option - 1

Parts Supplied

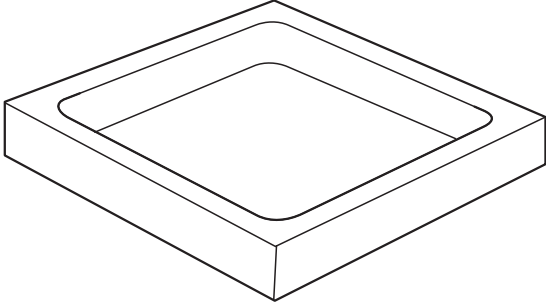
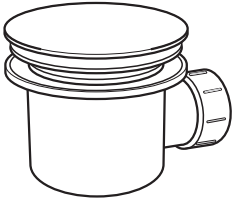
Ref.	Description	Qty.
A	Shower Tray  <p data-bbox="216 760 646 788"><i>* shape of tray may vary from illustration.</i></p>	1
B	Shower Waste (T5528AA) 	1

Tools and Materials Required - 1A & 1B (not supplied).

- Drill bit to suit floor screws
- Jigsaw
- Pencil
- Spirit Level
- Trowel
- Cement mortar mix as instructed by manufacturer with plasticiser additive or a Ceramic Floor Tile Adhesive
- Fine Sand
- Floor screws, suitable to fix marine plywood board to floor
- Masking Tape
- Plumbing pipe and fittings as necessary
- Sanitary Grade Silicone Sealant
- Screwdriver (cross-head)
- Silicone Cleaning Solvent

Additional for Installation Option - 1B

- Hole Cutter, size to suit the waste outlet with bottle trap used
- Marine Plywood board (18mm thick minimum)

Installation

OPTION 1A (Solid Floor)

Ensure you have the right tools and materials to hand with plenty of space and clean dry area for assembly.

1. With the shower tray (A) in position mark the perimeter and waste hole on the floor including an area outside the perimeter for access to connect plumbing after the tray has been installed, (see Fig. 1). If using a shower tray with a tiling upstand allowance must be made for recessing the tray into adjacent walls to allow tiling down onto the tray surface (see Fig. 1a).
2. Form a trench in the floor to hold the waste pipe and shower waste and extend to include the access area.
3. Install in accordance with building regulations the waste pipe and shower waste, also see page 15, (protecting any exposed threads with masking tape) in the trench, then blank off the trench so it remains clear (to enable plumbing connection) after laying a cement or suitable floor tile adhesive bed on the area to support the tray.

Note! Some shower trays have a protective film (indicated by a label on the surface) which must now be removed, undertake a final inspection of the tray at this stage.

Ensure the tray surface is protected for the rest of the installation.

4. If fitting the optional upstand seal (Flat Top Trays only) attach the seal now.
5. Mix fine sand, cement or suitable floor tile adhesive in accordance with the manufacturers instructions to a work-able mix to cover the total area under the tray. Trowel to a thickness suitable to allow levelling and full support of the shower tray with a minimum base of 10mm for the tile adhesive (see Fig. 2).

Figure 1

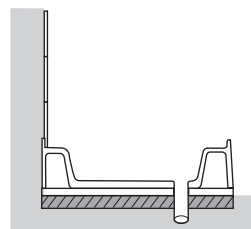
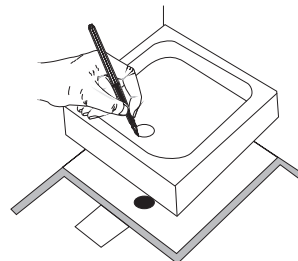
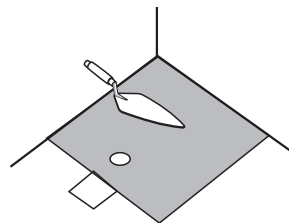

Figure 1a

Figure 2



Note! Silicone sealants, foams, mastics, or similar **MUST NOT** be used as a substitute for cement or suitable floor tile adhesive.

6. Place the shower tray (A) onto the bedding and ensure it is fully supported by the mix. Level the top rims only as the shower tray has a built in fall for adequate drainage (See Fig 3, Page 7).

7. When the bedding has set, remove any excess mix and masking tape then make connection between the shower tray and the waste pipe. The shower tray and all connections **MUST** now be checked for water tightness flow and adequate drainage over the entire area.
8. After all checks and adjustments, clean the shower tray rim using a silicone cleaning solvent (not supplied) seal along the tiling line with silicone sealant (see Fig. 4).

Note! When fitting a shower enclosure refer to the manufacturers installation instructions

9. Fill in the access area and the waste pipe trench beneath the shower tray (A) with cement or suitable floor tile adhesive to give full support to the shower tray in service.

Figure 3

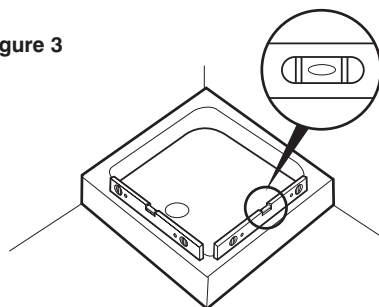
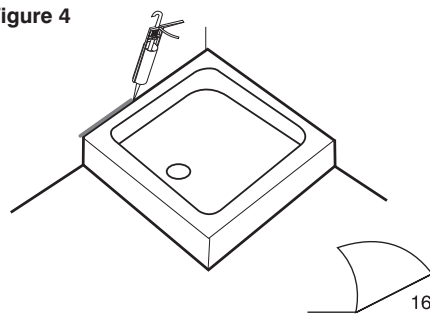

Figure 4



OPTION 1B (Suspended Floor)

1. Place shower tray (A) in position, mark the perimeter on the floor including an area outside the perimeter for access to connect plumbing after the tray has been installed (see Fig. 5, Page 8). If using a shower tray with a tiling upstand allowance must be made for recessing the tray into adjacent walls to allow tiling onto the tray surface (see Fig. 1a page 6).
 2. The floor area (or larger) covered by the shower tray (A) must be removed and replaced with a single piece of plywood (min 18mm thick) and also access for the waste should be constructed.
 3. Put the plywood in position, place the shower tray (A) on the plywood and mark the waste hole location (see Fig. 5, Page 8).
 4. Remove the shower tray (A), then use the hole cutter to drill a hole in the plywood large enough for the entire shower waste being used, which may need to be extended with the jigsaw to form a key-hole shaped cut-out for some types of shower waste. Keep all holes to the minimum (see Fig. 6, Page 8).
 5. Remove the plywood and install the waste outlet pipe in accordance with building regulation.
- Note!** Some shower trays have a protective film (indicated by a label on the surface) which must now be removed, undertake a final inspection of the tray at this stage.
- Ensure the tray surface is protected for the rest of the installation.

6. If fitting the optional upstand seal, (Flat top shower trays only) attach the seal now.
7. Install in accordance with building regulations the waste pipe and the shower waste to the shower tray (A), also see page 15, and protect exposed threads with masking tape. Before proceeding dry fit all items in situ to ensure compatibility and screw the plywood into position.
8. Mix fine sand, cement or suitable floor tile adhesive in accordance with the manufacturers instructions to a work-able mix to cover the total area under the tray. Trowel to a thickness suitable to allow levelling and full support of the shower tray with a minimum base of 10mm for the tile adhesive (A) (see Fig. 2, Page 6).

Note! *Silicone sealants, foams, mastics, or similar **MUST NOT** be used as a substitute for cement or suitable floor tile adhesive.*

9. Place the shower tray (A) onto the bedding and ensure it is fully supported by the mix. Level the top rims only as the shower tray has a built in fall for adequate drainage (see Fig. 3, Page 7).
10. When the bedding has set, remove any excess mix and masking tape then make connection between the shower tray and the waste pipe. The shower tray (A) and all connections **MUST** now be checked for water tightness flow and adequate drainage over the entire area.
11. After all checks and adjustments, clean

the shower tray rim using a silicone cleaning solvent (not supplied) seal along the tiling line with silicone sealant (see Fig. 4, Page 7).

Note! *When fitting a shower enclosure refer to the manufacturers installation instructions*

Figure 5

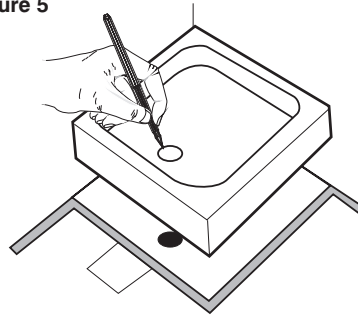
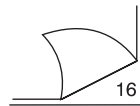
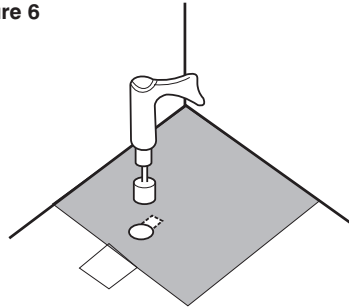
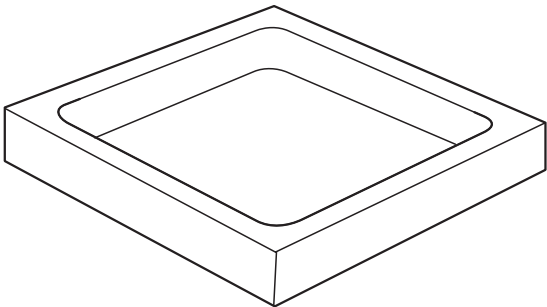
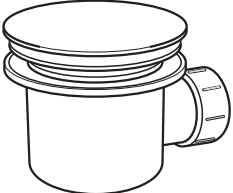

Figure 6















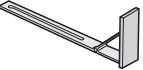

Installation Option - 2

Parts Supplied

Ref.	Description	Qty.
A	Shower Tray  <p data-bbox="216 725 647 751"><i>* shape of tray may vary from illustration.</i></p>	1
B	Shower Waste (T5528AA) 	1

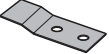
Parts Supplied

Ref.	Description		Qty.		
			120 Riser Kit L630901	Quad Riser Kit L631001	Ext Riser Kit L631201
C1	1200mm Universal Straight Panels		2	N/A	N/A
C2	1700mm Universal Straight Panels		N/A	N/A	1
C3	Universal Curved Panel Quad Panel		N/A	1	N/A
D	Leg Mounting Brackets		8	8	4
E	Threaded Leg Tubes		8	8	4
F	Circular Base Plates		8	8	4
G	Screws for Leg Mounting & Panel Upright Brackets		28	28	16
H	Panel Upright Brackets		6	6	N/A
I	Adhesive Hook & Loop Pads		6	6	N/A
J	Corner/End Brackets		3	3	N/A
K	Joining Brackets		2	2	N/A
L	Pentangle Joining Brackets		2	2	N/A
M	Circular Adhesive Pads		8	8	4
N	Floor Brackets		4	4	N/A
O	Floor Bracket Screws		8	8	N/A

Tools and Materials Required (not supplied).

- Cross-Head Screw Driver
- Sharp Knife and or Mitre Saw
- Spirit Level
- Pipework and fittings as required
- Spirit Level
- Sanitary Grade Silicone Sealant
- Tape measure
- Marker Pen
- Silicone Cleaning Solvent

Area Preparation:

Note! Any floor area under the tray MUST be rigid and level.

1. Place the shower tray in the intended area of installation and mark the waste position and the outline of the tray on the floor (see Fig.1).
2. Remove the shower tray and screw the floor brackets (N) using screws (O) to the floor with the open end 2mm back from the marked line evenly spaced parallel with the sides adjacent the intended panel access sides. Adjust the open end of the floor brackets (N) to accept the bottom edge of the panels (A or B) nominally 1.5mm (see Fig.2).

Note! On concrete floors, discard screws (O) supplied, alternative fixings (not supplied) will be required.

3. Install pipework to the area (not supplied) in accordance with the building regulations, mark the waste outlet position and attach the Waste Outlet (not supplied with pack), (see Fig. 3).

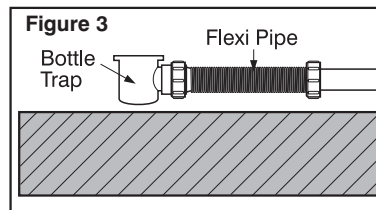
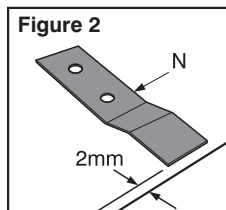
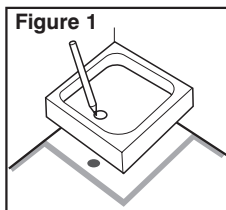

Leg assembly

Ensure you have the right tools and materials to hand with plenty of space and clean dry area for assembly.

1. Screw all the leg mounting brackets (D) to the upper square face of the base plates (F) using screws (G) (see Fig. 1).
2. Attach the circular adhesive pads (M) to the under side of all the circular base plates (F) by removing the self adhesive backing paper from one side ONLY of the adhesive pads (M), centralise and push firmly into position (see Fig. 2).

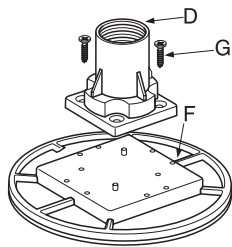

Figure 1

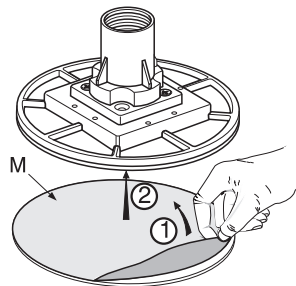
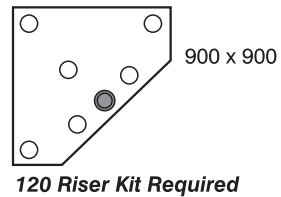
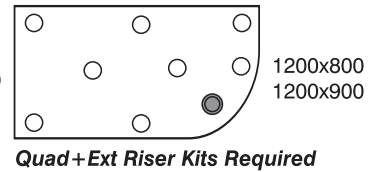
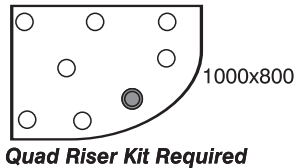
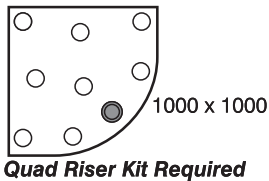
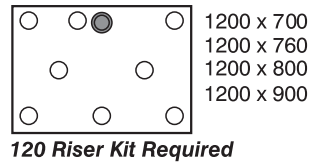
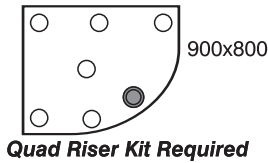
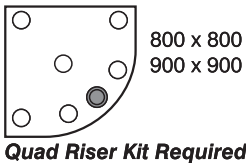
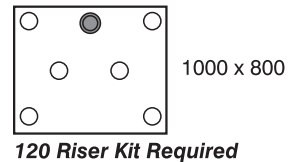
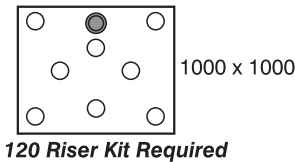
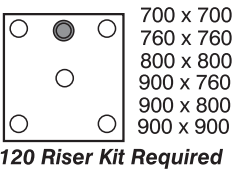
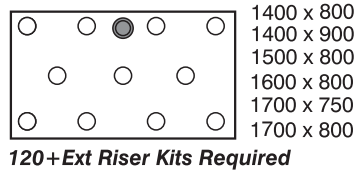
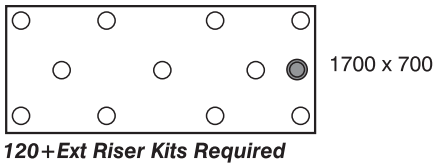



Figure 2

Leg Positioning

1. With your chosen shower tray upside down, position all (DO NOT PERMANENTLY FIX UNTIL STEP 3) the leg assemblies to form an evenly supported structure. Wherever possible use the full number of leg assemblies available for maximum support. For guidance, see below.

N.B. Some types of shower trays may not require the use of all the legs available with this kit. Images below are of the underside of the trays.



-  waste position
-  leg positions

2. Attach the panel upright brackets (H) using screw(s) (G) to the circular base plates (F) that are located on the panel access sides of the tray, Fig. 3.
3. Once an evenly supported layout plan has been achieved, ensure the base of the tray is clean and free from dust and other contaminants, then remove the remaining self adhesive backing paper from the assembled pads (M) and attach all leg assemblies permanently into position, Fig. 4.
4. Adjust the panel upright brackets (H) to achieve a nominal 6mm gap between the bracket and the tray edge (see Fig. 5).
5. Screw all the threaded leg tubes (E) into the feet mounting brackets (D) to achieve a nominal 96mm from the base of the tray to base of the leg, (see Fig. 6).
6. Place the shower tray upright, remove protective film, undertake a final inspection of the tray at this stage. Ensure the tray surface is protected for the rest of the installation. Level the tray into position, install in accordance with building regulations the waste pipe and the shower waste to the tray, also see page 15. Adjust the threaded leg tubes (E) as required maintaining a nominal 95mm gap between the edge of the shower tray and the floor.
7. The shower tray and all connections MUST now be checked for water tightness, flow and adequate drainage over entire area.

Figure 3

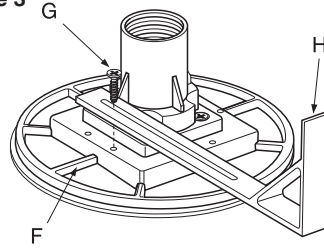

Figure 4

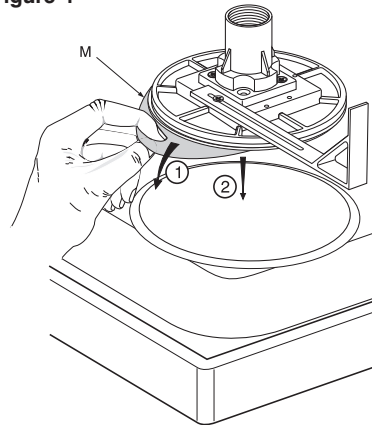

Figure 5

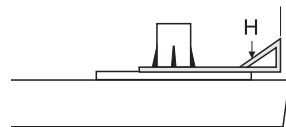
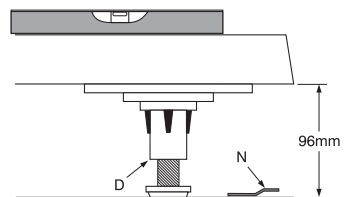

Figure 6



Panel Installation

- Using panels (C1/C2 or C3) measure and cut using a sharp knife or mitre saw for the size and shape of shower tray being installed up to 1200mm, (see Figs. 7, 8 and 9).

Note! Some panels have a protective film (indicated by a label on the surface) which must be removed now.

- For shower trays greater than 1200mm up to 1700mm, use optional extension kit L631201.
- Assemble the panel shape by removing the coloured adhesive backing paper from the brackets being used either (J, K and or L) as required and firmly attach to the panels as shown, (see Figs. 7, 8 and 9).
- Using the Adhesive Hook & Loop Pad sets (I) remove the self adhesive backing paper from one side ONLY and attach to the ends of the panel upright brackets (H) (see Fig. 10a).
- Test fit all panels by sliding into Floor Brackets (N) before final assembly and ensure correct orientation to fit as required.
- Remove the remaining self adhesive backing papers from the attached Adhesive Hook & Loop Pad sets (I), (see Fig. 10b), and push the panel assembly firmly into position.
- After tiling & before fitting of the enclosure, clean shower tray rim using a silicone cleaning solvent (not supplied).
- After all checks and adjustments, seal along the tiling line with a suitable silicone sealant (see Fig. 11).

Note! Once the panel assembly is correctly in place it **MUST** be sealed along the joining edge if using only the floor brackets (N) to hold the panels in situ (see fig 12).

Figure 7

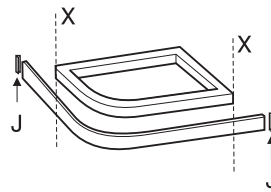

Figure 8

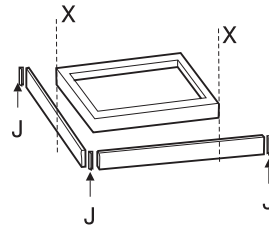

Figure 9

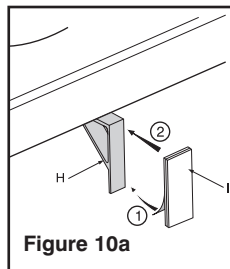
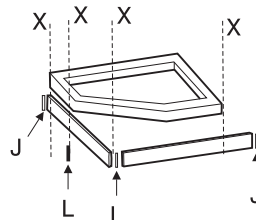

Figure 10a

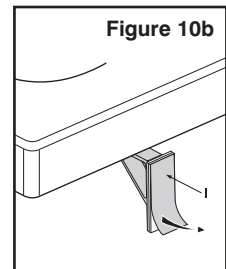

Figure 10b

Figure 11

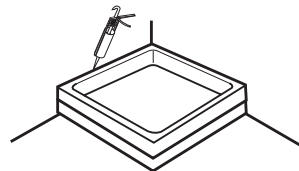
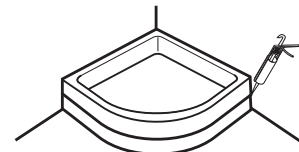

Figure 12



SHOWER TRAY WASTE (Ref. B).

Installation and Assembly Instructions

1. Remove upper assembly and seal from the bottle trap.
2. Re-assemble onto the shower tray as shown in diagram below.

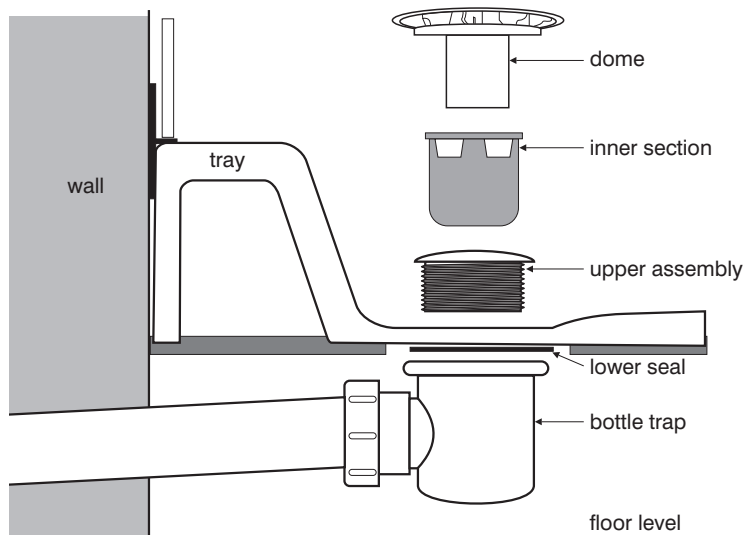

3. To clean the trap, carefully pull the dome from the unit then pull the inner section from the assembly.
Wipe clean only and re-fit.

N.B.: A suitable sealant *MUST* be used between all mating surfaces against the tray during installation.

Care & Use of Your Shower Tray

Water feeds where possible should not be connected to a water softener system as salts used with some types of units may discolour the surface.

It is normal for small amounts of localized water to be retained in the shower tray after use which should be wiped dry immediately to prevent build up of mineral sediments.

The shower tray should be cleaned with warm, soapy water only. Do not use scourers, abrasives or chemical cleaners.

Troubleshooting

- Q** The shower waste in the shower tray is directly over an obstruction at floor level.
- A** Consider switching to the use of a riser kit or re-locating shower tray.
- Q** The shower waste will not fit through the plywood and connect with the pipe run.
- A** Cut a slightly larger hole with a key hole section over the connection point.
- Q** There is water retaining in the base of tray.
- A** Check that the tray is level (top rims) as it is normal for small amounts of localized water to be retained.

CUSTOMER CARE HELPLINE

01482 496318

CUSTOMER CARE FAX LINE 01482 499611

email: customercare@idealstandard.com

We pursue a policy of continuing improvement in design and performance of our products. The right is, therefore, reserved to vary specifications without notice.

4995 07/23