

CLASSIC DUO

- Pure simplicity and unpretentious elegance are what distinguish these baths
- Classic four-cornered model
- Bathing with a friend: two identical back rests and centrally positioned waste
- Made of KALDEWEI steel enamel

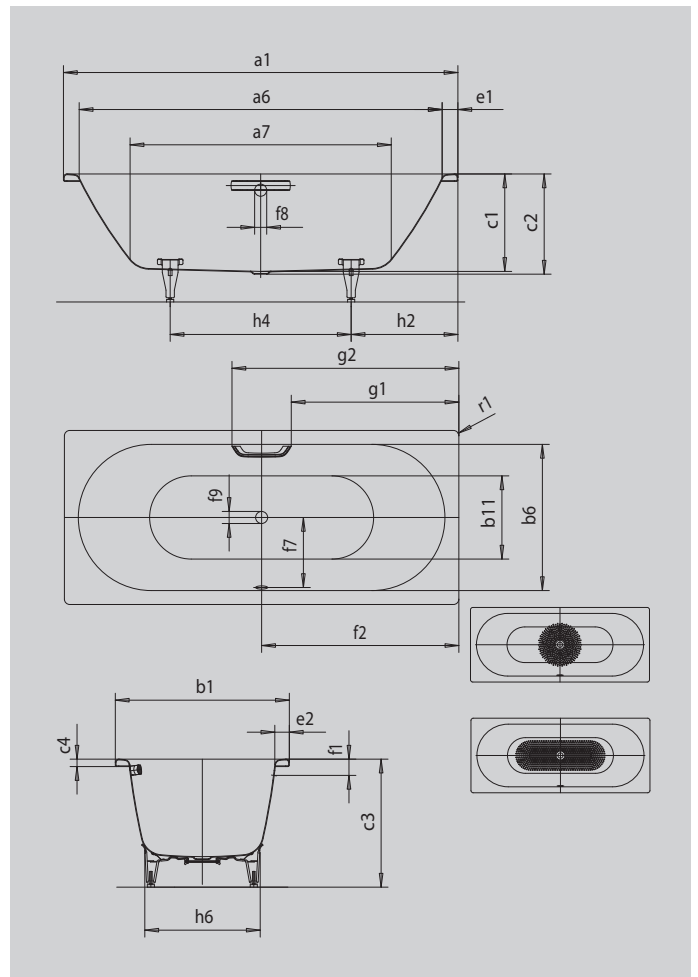

Similar illustration



GRIP DISCREET OPULENCE

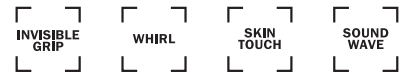

Model		105
External length [mm]	a ₁	1700 mm
Internal length (top) [mm]	a ₆	1580 mm
Internal length (bottom) [mm]	a ₇	1130 mm
External width [mm]	b ₁	700 mm
Internal width (top) [mm]	b ₆	580 mm
Internal width (bottom) [mm]	b ₁₁	450 mm
Depth inside [mm]	c ₁	420 mm
Depth incl. waste hole [mm]	c ₂	430 mm
Height with feet [mm]	c ₃	565 - 600 mm
Height of rim [mm]	c ₄	32 mm
Width of rim (foot end; long side) [mm]	e ₁ ; e ₂	60; 60 mm
Distance top edge to centre of overflow hole [mm]	f ₁	70 mm
Distance bath edge to centre of waste hole [mm]	f ₂	850 mm
Distance centre of waste hole to centre of overflow hole [mm]	f ₇	280 mm
Diameter of overflow hole [mm]	f ₈	Ø 52 mm
Diameter of waste hole [mm]	f ₉	Ø 52 mm
Distance bath edge (foot end) to start of grip [mm]	g ₁	722 mm
Distance bath edge (foot end) to end of grip [mm]	g ₂	978 mm
Distance foot end of bath edge to centre of foot [mm]	h ₂	560 mm
Distance between the feet [mm]	h ₄	580 mm
Width of feet max. [mm]	h ₆	420 mm
External radius [mm]	r ₁	8 mm
Water volume [l]		110 l
Net weight [kg]		47 kg
Pedestal		5030
Diameter of anti-slip [mm]		Ø 288 mm
Full anti-slip		900 x 300 mm

Subject to technical alterations, tolerances and errors. Similar illustration. 70 litres displacement on average.

KALDEWEI