

Sales Code: NTP101

Description: Offset Quad Tray Lh 900 X 760

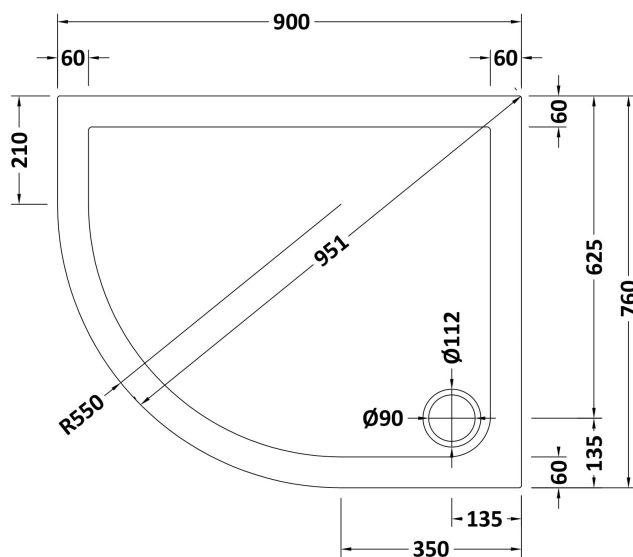

Product Dimensions

Length (mm):	900
Width (mm):	760
Height (mm):	40
Nett Weight (kg):	19.5

Packaging Dimensions

Length (mm):	940
Width (mm):	800
Height (mm):	80
Gross Weight (kg):	19.8

Packaging Data

Box Colour:	Shrinkwrap & Polystyrene
Box Qty:	1
Label Size:	100 x 50
Label Colour:	White Label
Label Qty:	2

Outer Box Dimensions (If Applicable)

Length (mm):	
Width (mm):	
Height (mm):	
Gross Weight (kg):	
Barcode:	5055369006076

Product Details

Country of Origin:	United Kingdom
Fitting Instruction:	No
CE & UKCA:	Yes
Colour/Finish:	White
Product Material:	Acrylic Capped ABS Caco3 & Pu
Material Colour Reference:	European White
Radius:	550
Waste Required (mm):	90
Compatible with Leg Kit:	Yes