

Sales Code: NLT91105

Description: Quadrant Shower Tray 800X800

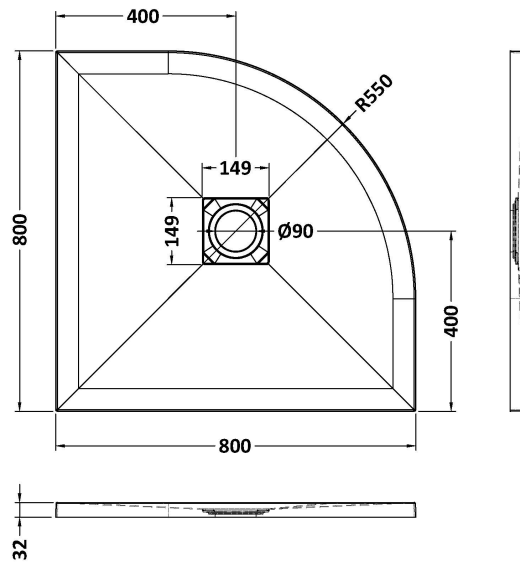
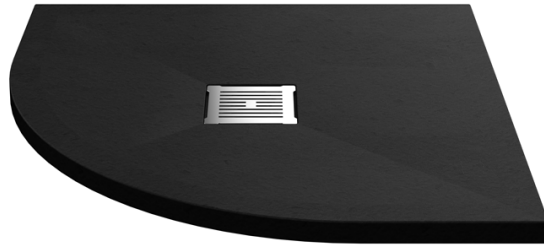

Product Dimensions

Length (mm):	800
Width (mm):	800
Height (mm):	33
Nett Weight (kg):	31.9

Packaging Dimensions

Length (mm):	840
Width (mm):	840
Height (mm):	73
Gross Weight (kg):	32.2

Packaging Data

Box Colour:	Shrinkwrap & Polystyrene
Box Qty:	1
Label Size:	100 x 50
Label Colour:	White Label
Label Qty:	2

Outer Box Dimensions (If Applicable)

Length (mm):	
Width (mm):	
Height (mm):	
Gross Weight (kg):	
Barcode:	5056462656137

Product Details

Country of Origin:	United Kingdom
Fitting Instruction:	No
CE & UKCA:	Yes
Colour/Finish:	Slate Black
Product Material:	Acrylic Capped ABS Caco3 & Pu
Material Colour Reference:	Slate Black
Radius:	550
Waste Required (mm):	90
Compatible with Leg Kit:	No