

**Sales Code:** NLT91063

**Description:** Rectangular Shower Tray 1700X800

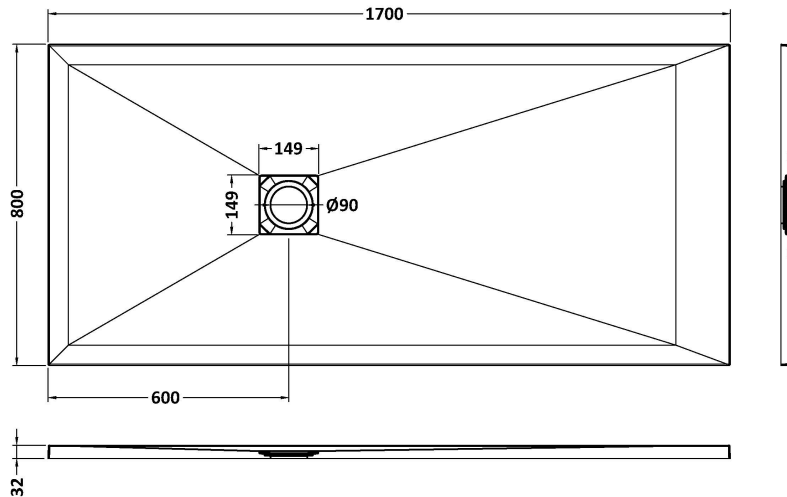

**Product Dimensions**

Length (mm):	1700
Width (mm):	800
Height (mm):	33
Nett Weight (kg):	65.2

**Packaging Dimensions**

Length (mm):	1740
Width (mm):	840
Height (mm):	73
Gross Weight (kg):	65.5

**Packaging Data**

Box Colour:	Shrinkwrap & Polystyrene
Box Qty:	1
Label Size:	100 x 50
Label Colour:	White Label
Label Qty:	2

**Outer Box Dimensions (If Applicable)**

Length (mm):	
Width (mm):	
Height (mm):	
Gross Weight (kg):	
Barcode:	5056462656434

**Product Details**

Country of Origin:	United Kingdom
Fitting Instruction:	No
CE & UKCA:	Yes
Colour/Finish:	Slate Black
Product Material:	Acrylic Capped ABS Caco3 & Pu
Material Colour Reference:	Slate Black
Radius:	0
Waste Required (mm):	90
Compatible with Leg Kit:	No