



# SHOWER BATH-LEG FITTING INSTRUCTION

3. x4  160mm

4. x4  45mm

5. x12  13mm

6. x4 

7. x12



∅ 10

8. x4



9. x4

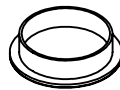

550mm

2. x1

650mm

1. x1

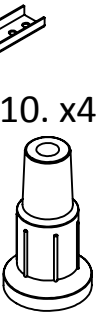

10. x4

1.

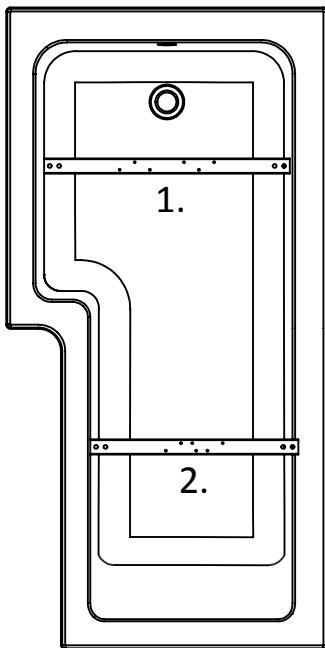

2.

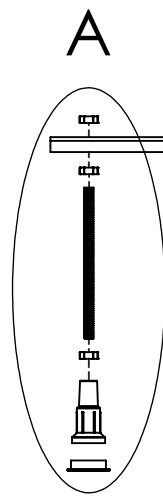

DETAIL VIEW: A

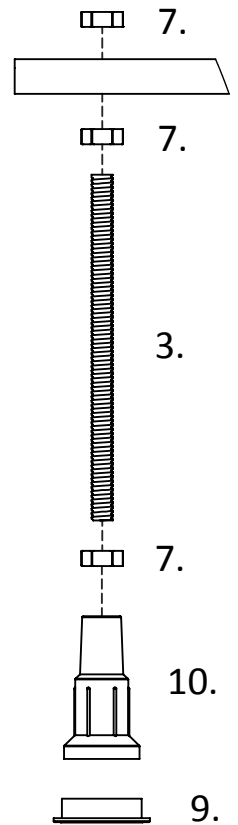

3.

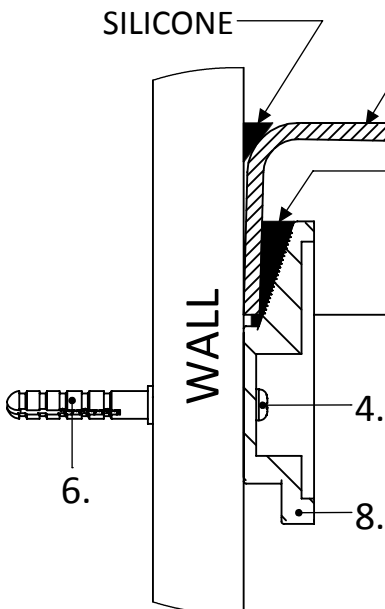

4.

