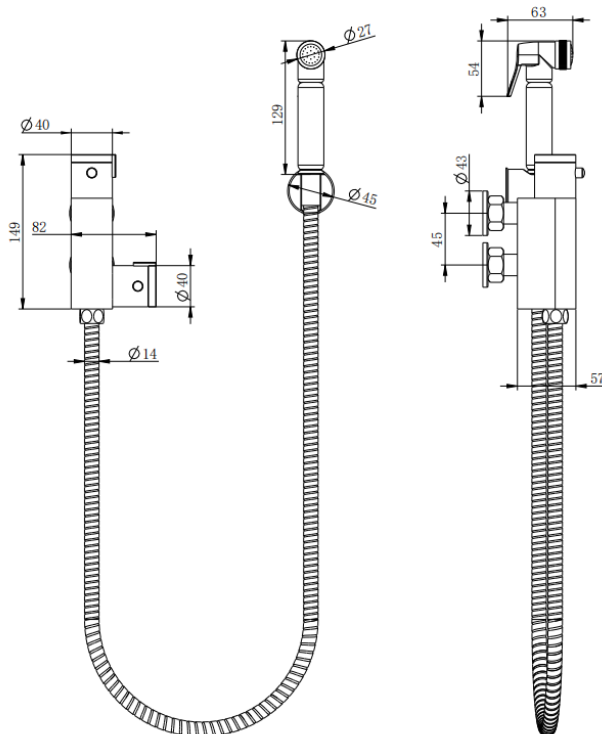

SHO053DO- Douche Kit with Therm. Mixing Valve and Brass Spray Head

BAR CODE: 5055681437947
COLOUR: CHROME
WEIGHT:
NET 1.64 kg
GROSS 2.18 kg
STANDARDS: BS EN 1111
NOTES:
SUITABLE FOR PRESSURES BETWEEN 0.2 - 5 BAR
HOT & COLD PRESSURES MUST BE BALANCED
SUITABLE FOR COMBI- BOILERS, UNVENTED MAINS
PRESSURE SYSTEMS AND GRAVITY FED SYSTEMS
SUITABLE FOR SHOWER PUMPS
ANTI SCALD (THERMO STOP SET AT 38°C)
SINGLE FUNCTION HAND SET
Flow Rate:

0.2 bar	0.5 bar	1 bar	2 bar	3 bar	5 bar
7 L	9.1 L	13.6 L	19.6 L	24.4 L	30.9 L

BOX SIZE 360X297X124