

SHO059DN- Nero Douche Kit with Therm. Mixing Valve Matt Black
BAR CODE: 5055681444938

COLOUR: MATT BLACK

WEIGHT:
NET 1.64 kg

GROSS 2.18 kg

STANDARDS: BS EN 1111

NOTES:
SUITABLE FOR PRESSURES BETWEEN 0.2 - 5 BAR
HOT & COLD PRESSURES MUST BE BALANCED
SUITABLE FOR COMBI- BOILERS, UNVENTED MAINS
PRESSURE SYSTEMS AND GRAVITY FED SYSTEMS
SUITABLE FOR SHOWER PUMPS
ANTI SCALD (THERMO STOP SET AT 38°C)
SINGLE FUNCTION HAND SET
Flow Rate:

0 . 2 bar	0 . 5 bar	1 bar	2 bar	3 bar	5 bar
7 L	9.1 L	13.6 L	19.6 L	24.4 L	30.9 L

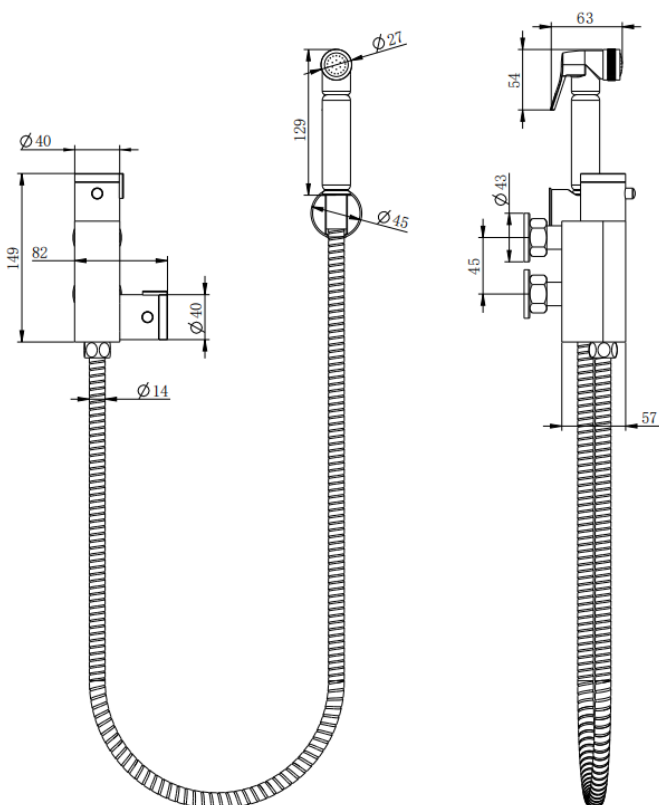
BOX SIZE 360X297X124

IMAGE