

Plan

Bath Shower Mixer TAP012PL

Supplied with Click Waste

3/4" BSP Connections

Suitable for low water pressure systems

Brass construction with chrome plated finish



Technical drawing

Flow Rate: M.P

0.2bar	0.5bar	1bar	2bar	3bar
1.77L/min	2.71L/min	6.27L/min	9.31L/min	12.17L/min

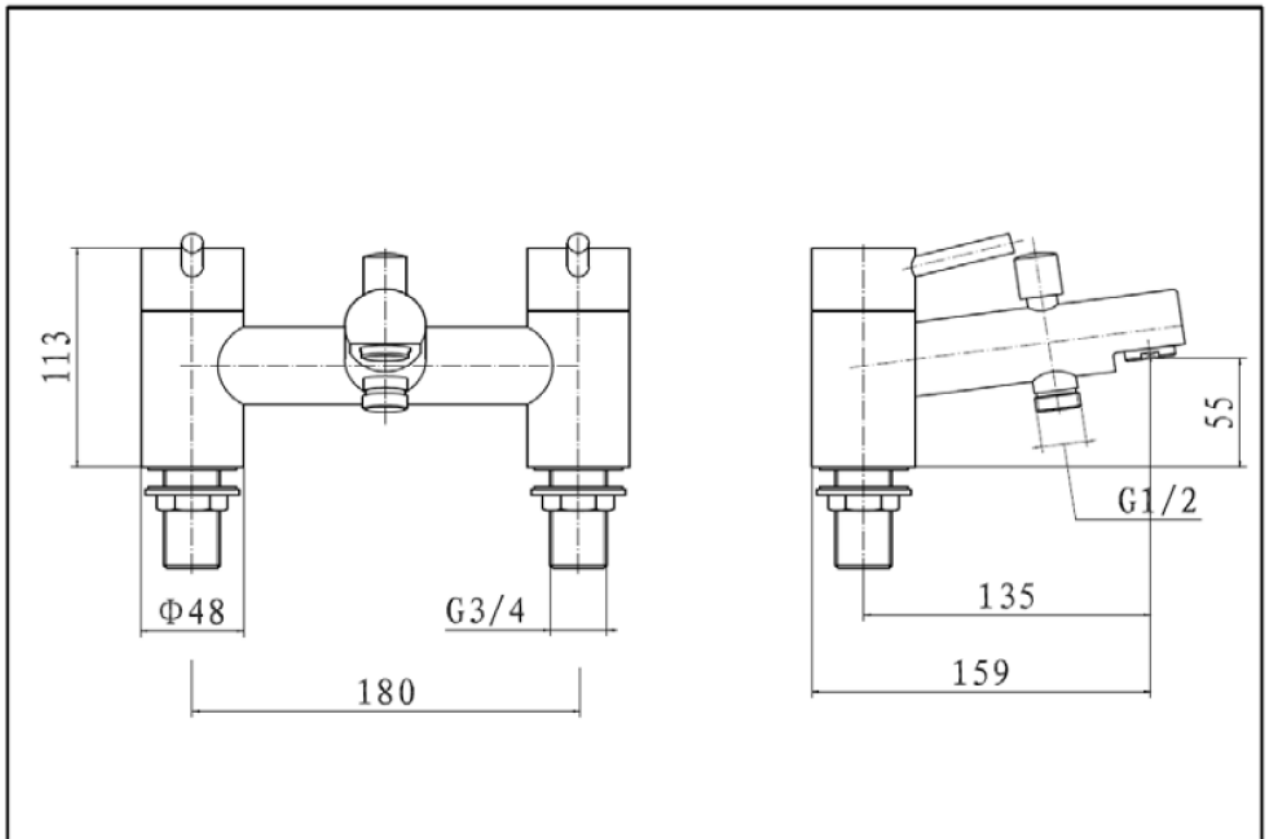

BOX SIZE 250 x 190 x 180 mm