

The background is a full-page image of a marbled ceramic surface, likely a wall or floor, with intricate patterns of grey, black, and brown veins on a light cream base. The pattern is symmetrical down a vertical line. In the bottom-left corner, a portion of a light-colored wooden chair is visible, with a rolled-up beige towel resting on its seat.

Surfaces

Porcelain and Ceramics

2024

RAK
CERAMICS

Index by Alphabetical

A	
Amani Marble	28
B	
Bahia Wave	32
Basic Concrete	158
Black Beauty	36
Blu Del Belgio	40
Breccia	44
C	
Calacatta	48
Calacatta Gold	224
Calacatta Grey	226
Carmo Stone	116
Carmo Stone Outdoor	222
Carrara	192
Chiltern	194
Circle Wood	106
City Stone	120
Classic Carrara	52
Clay Stone	124
Cumbria	198
Curton	128
D	
Detroit Metal	96
E	
Evoque Metal	100
F	
Fashion Stone	132
Fashion Stone Outdoor	228
L	
Lapideus	136
Line Wood	110
Loft Concrete	162
Lounge	166
Luce	56

M	
Marakkesh	202
Maremma	140
Maremma Outdoor	230
Medicea Marble	62
Monza	206
P	
Paleo	144
Palissandro	66
Panda Marble	70
Preziosi	74
R	
Rain Marble	78
RAK Stone 2.0	232
Rapolano	148
S	
Sensation White	210
Shine Stone	154
Stone Lagoon	234
Subway	212
Surface XL	182
Surface 2.0	172
Surface 2.0 Outdoor	236
Symphony	178
T	
Taj Mahal	182
Tech-Marble	80
U	
Uni Dark Black	182
Urban Marble	84
V	
Venato Marble	86
Versilia Marble	90
W	
Warwick	216

Index by Look

Marble	
Amani Marble	28
Bahia Wave	32
Black Beauty	36
Blu Del Belgio	40
Breccia	44
Calacatta	48
Classic Carrara	52
Luce	56
Medicea Marble	62
Palissandro	66
Panda Marble	70
Preziosi	74
Rain Marble	78
Tech-Marble	80
Urban Marble	84
Venato Marble	86
Versilia Marble	90
Metal	
Detroit Metal	96
Evoque Metal	100
Wood	
Circle Wood	106
Line Wood	110
Stone	
Carmo Stone	116
City Stone	120
Clay Stone	124
Curton	128
Fashion Stone	132
Lapideus	136
Maremma	140
Paleo	144
Rapolano	148
Shine Stone	154

Concrete	
Basic Concrete	158
Loft Concrete	162
Lounge	166
Surface 2.0	172
Symphony	178
Countertop Collection	182
Ceramic Wall Tiles	
Carrara	192
Chiltern	194
Cumbria	198
Marakkesh	202
Monza	206
Sensation White	210
Subway	212
Warwick	216
Outdoor	
Carmo Stone Outdoor	222
Calacatta Gold	224
Calacatta Grey	226
Fashion Stone Outdoor	228
Maremma Outdoor	230
RAK Stone 2.0	232
Stone Lagoon	234
Surface 2.0 Outdoor	236



Index by Size

135x305

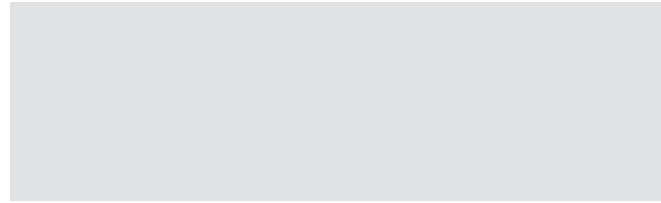

Black Beauty	182
Blu Del Belgio	40
Breccia	182
Calacatta	48
Calacatta Africa	182
Calacatta Gold	182
Classic Carrara	52
Medicea Marble	62
Rain Marble	78
Surface XL	182
Surface 2.0	172
Taj Mahal	182
Uni Dark Black	182
Versilia Marble	90

120x260

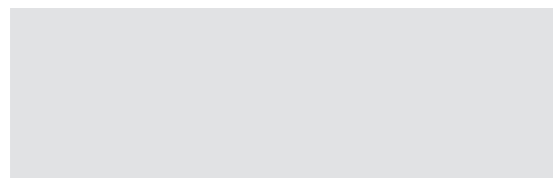

Blu Del Belgio	40
Breccia	44
Calacatta	48
Classic Carrara	52
Luce	56
Medicea Marble	62
Rain Marble	78
Palissandro	66
Panda Marble	70
Preziosi	74
Rain Marble	78
Surface 2.0	172
Versilia Marble	90

120x240

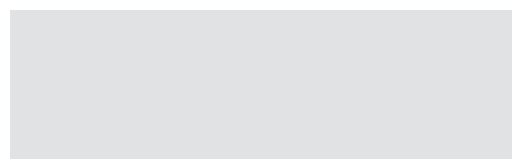

Amani Marble	28
Bahia Wave	32
Black Beauty	36
Blu Del Belgio	40
Calacatta	48
Classic Carrara	52
Medicea Marble	62
Panda Marble	70
Venato Marble	86
Versilia Marble	90

120x120

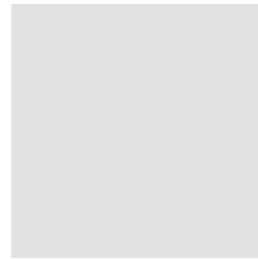

Amani Marble	28
Bahia Wave	32
Black Beauty	36
Blu Del Belgio	40
Breccia	44
Calacatta	48
Classic Carrara	52
Medicea Marble	62
Panda Marble	70
Preziosi	74
Surface 2.0	172
Venato Marble	86
Versilia Marble	90

60x120

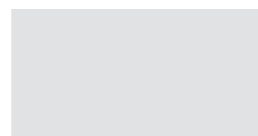

Amani Marble	28
Bahia Wave	32
Black Beauty	36
Blu Del Belgio	40
Breccia	44
Calacatta	48
Calacatta Gold	224
Calacatta Grey	226
Carmo Stone	116
Carmo Stone Outdoor	222
City Stone	120
Classic Carrara	52
Curton	128
Detroit Metal	96
Evoque Metal	100
Lapideus	136
Maremma	140
Maremma Outdoor	230
Medicea Marble	62
Palissandro	66
Panda Marble	70
Rain Marble	78
RAK Stone 2.0	232
Stone Lagoon	234
Surface 2.0	172
Tech-Marble	80
Urban Marble	84
Venato Marble	86
Versilia Marble	90

Index by Size

19.5x120

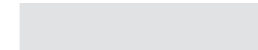

Circle Wood	106
Line Wood	110

80x80



Amani Marble	28
Calacatta	48
Classic Carrara	52
Paleo	144
Rapolano	148
Surface 2.0	172

60x60



Basic Concrete	158
Chiltern	194
City Stone	120
Clay Stone	124
Curton	128
Detroit Metal	96
Evoque Metal	100
Fashion Stone	132
Fashion Stone Outdoor	228
Lapideus	136
Loft Concrete	162
Lounge	166
Maremma	140
Shine Stone	154
Surface 2.0	172
Surface 2.0 Outdoor	236
Tech-Marble	80

30x60

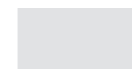

Basic Concrete	158
Carrara	192
Chiltern	194
City Stone	120
Clay Stone	124
Cumbria	198
Fashion Stone	132
Loft Concrete	162
Lounge	166
Monza	206
Sensation White	210
Shine Stone	154
Surface 2.0	172
Warwick	216

29.8x60



Curton	128
Detroit Metal	96

15x60

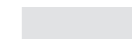

Shine Stone	154
-------------	-----

10x60

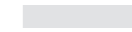

Shine Stone	154
-------------	-----

5x60



Shine Stone	154
-------------	-----

45x45



Carrara	192
Cumbria	198
Monza	206
Warwick	216

10x30



Subway	212
--------	-----

6.5x26



Marakkesh	202
Subway	212

20x20



Symphony	178
----------	-----

15x15



Marakkesh	202
-----------	-----

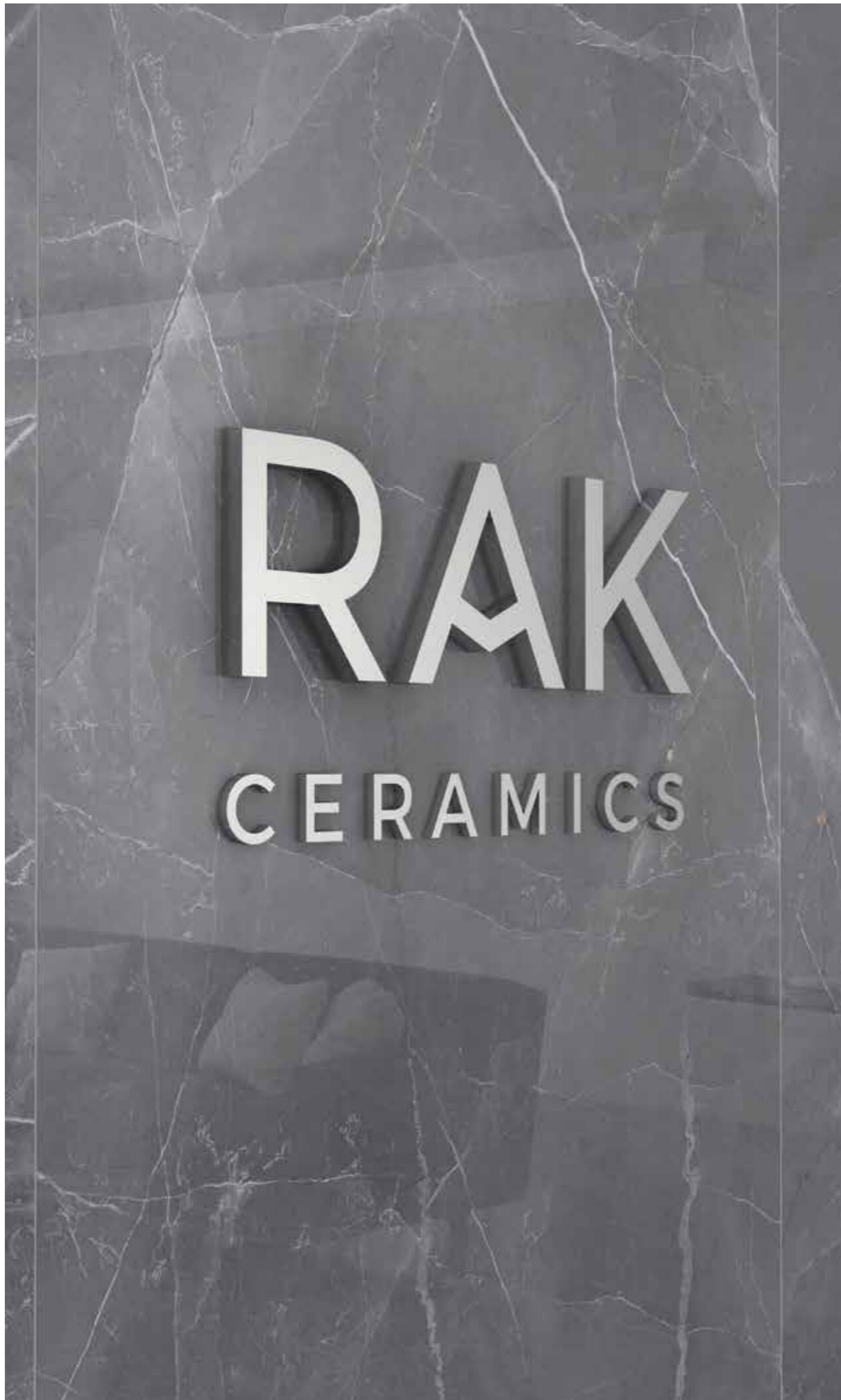

Focused on ceramics expertise

RAK Ceramics is one of the largest ceramics brands in the world. Specialising in ceramic and gres porcelain wall and floor tiles and sanitaryware, the company has the capacity to produce 123 million square metres of tiles and 5 million pieces of sanitaryware per year at its state-of-the-art plants across the United Arab Emirates, India and Bangladesh.

Founded in 1989 and headquartered in the United Arab Emirates, RAK Ceramics serves clients in more than 150 countries through a network of operational hubs in Europe, Middle East and North Africa, Asia, North and South America and Australia. Across global operations the company employs approximately 15,000 staff from more than 40 nationalities. RAK Ceramics is a publicly listed company on the Abu Dhabi Securities Exchange in the United Arab Emirates and as a group has an annual turnover of approximately US\$1 billion.

Forged in the mountains of Ras Al Khaimah

RAK Ceramics was established in Ras Al Khaimah in 1989 by H.H. Sheikh Saud Bin Saqr Al Qasimi, member of the Supreme Council and Ruler of Ras Al Khaimah, who aspired to have the best machinery, latest technology, and to produce the best products possible for sale in the world.

Now under the vision and leadership of Sheikh Khalid Bin Saud Al Qasimi, Chairman of RAK Ceramics, the company has enjoyed rapid growth, becoming an industry leader in just 30 years.





INNOTECH - RAK CERAMICS LAB

Innovation is at the heart of RAK Ceramics' philosophy. The company is a pioneer in introducing hi-tech innovations that are a breakthrough in the industry and a world leader in the production of ceramic and porcelain tiles, ideal for use in indoor and outdoor spaces for wall and floor coverings for residential, retail and industrial projects.

A wide range of technologies are used at the state-of-the-art plants including big slabs pressing technology, advanced digital printing technology for industrial decoration and effects, translucent, double and triple charged feeding systems, digital soluble salts, thermal resistant komfy glaze, slim, anti-microbial, glow in the dark, and other advanced technologies.

RAK Ceramics is known for its wide product range and size range, and for its ability to produce bespoke ranges for both small and large scale projects, enabling its clients to bring their ideas to life.

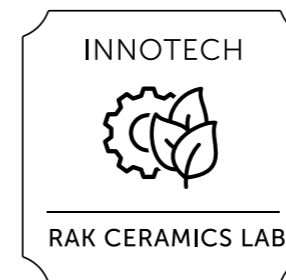

RAK SANIT



The antibacterial revolution

RAK-Sanit is a complete solution that includes porcelain and ceramic tile collections that reduce bacterial contamination and contribute to a healthier living and working environment owing to its antibacterial properties given by silver nitrate compounds.

The RAK-Sanit antibacterial collection of wall and floor tiles features antibacterial technology that is permanently integrated into the tile surface. Once bacteria comes into contact with the tiled surface, the silver ions initiate the elimination cycle. Silver ions in the antibacterial tile surface bind to enzymes, proteins, cell membranes, and the DNA of the microbe to damage DNA and block reproduction, resulting in the death of the organisms.

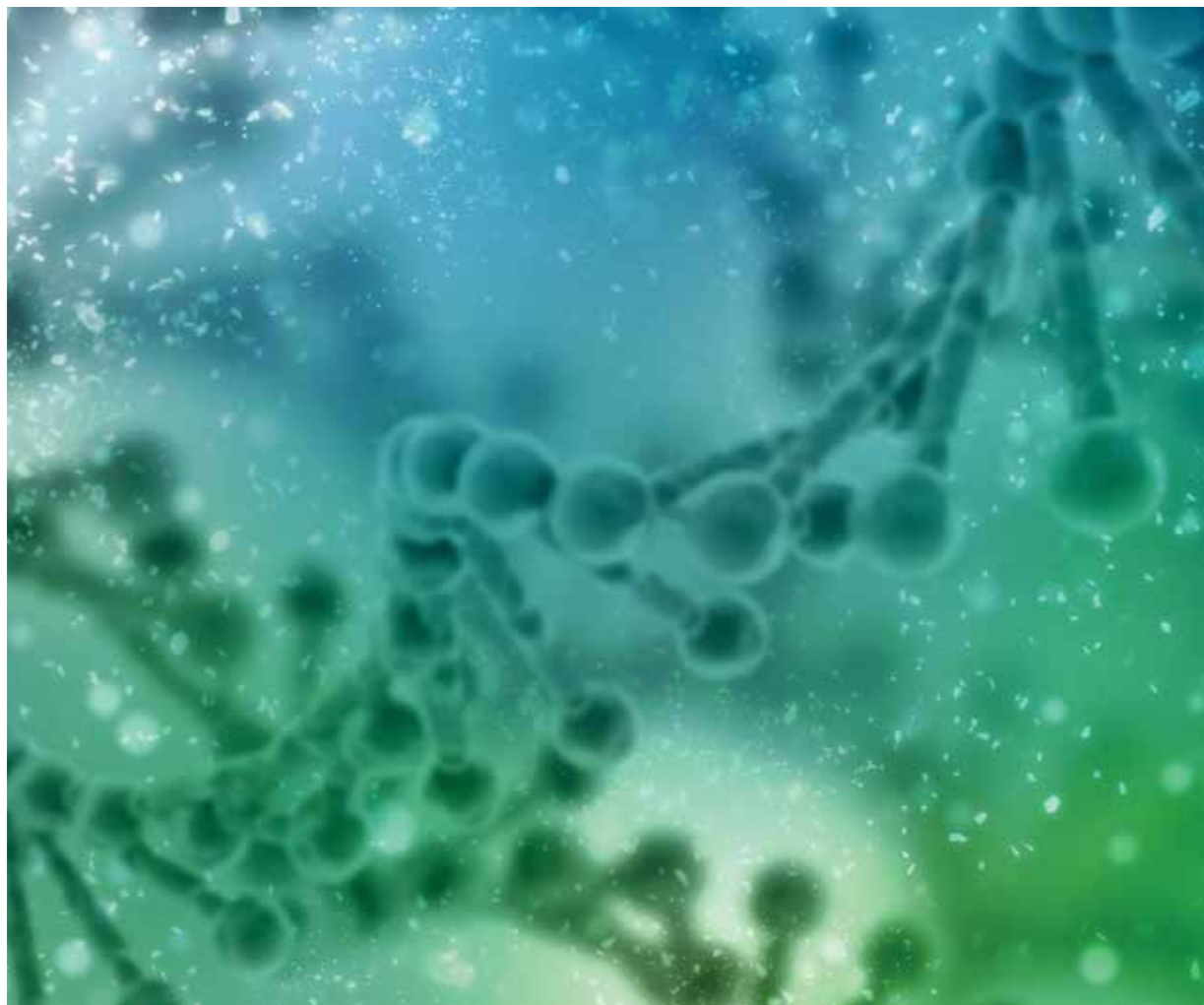

HIGH PERFORMANCE



Highly technical and extremely versatile surfaces

With a dedicated production technology able to deliver the most modern high-performing surface solution, a new variety of full-body porcelain stoneware is created. These tiles are produced using the most modern system and quality materials resulting in an extraordinary natural, high-performing variety of porcelain tiles with unique characteristics and limitless applications.

Its natural and structured features make it the perfect solution for architects' and interior designers' contemporary design needs.



KLIMA



Heat adaptive technology on porcelain tiles

Klima is a new-generation ceramic tile that can absorb and repel heat according to individual needs, thanks to the special materials used during production.

When applied to indoor flooring, Klima retains room heat and releases it over the entire surface, producing a warmer feel than a standard floor. When installed on outdoor flooring, Klima repels the heat from sunlight, resisting high temperatures. As a result, even with significant sun exposure, the surface is not burning hot, and the floor remains cool and pleasant to walk on with bare feet. On ventilated façades, Klima helps limit heat dispersion while maintaining a steady indoor temperature.

Klima tiles are suitable for indoor and outdoor applications, for flooring or external walls, to achieve maximum comfort with minimum energy impact.

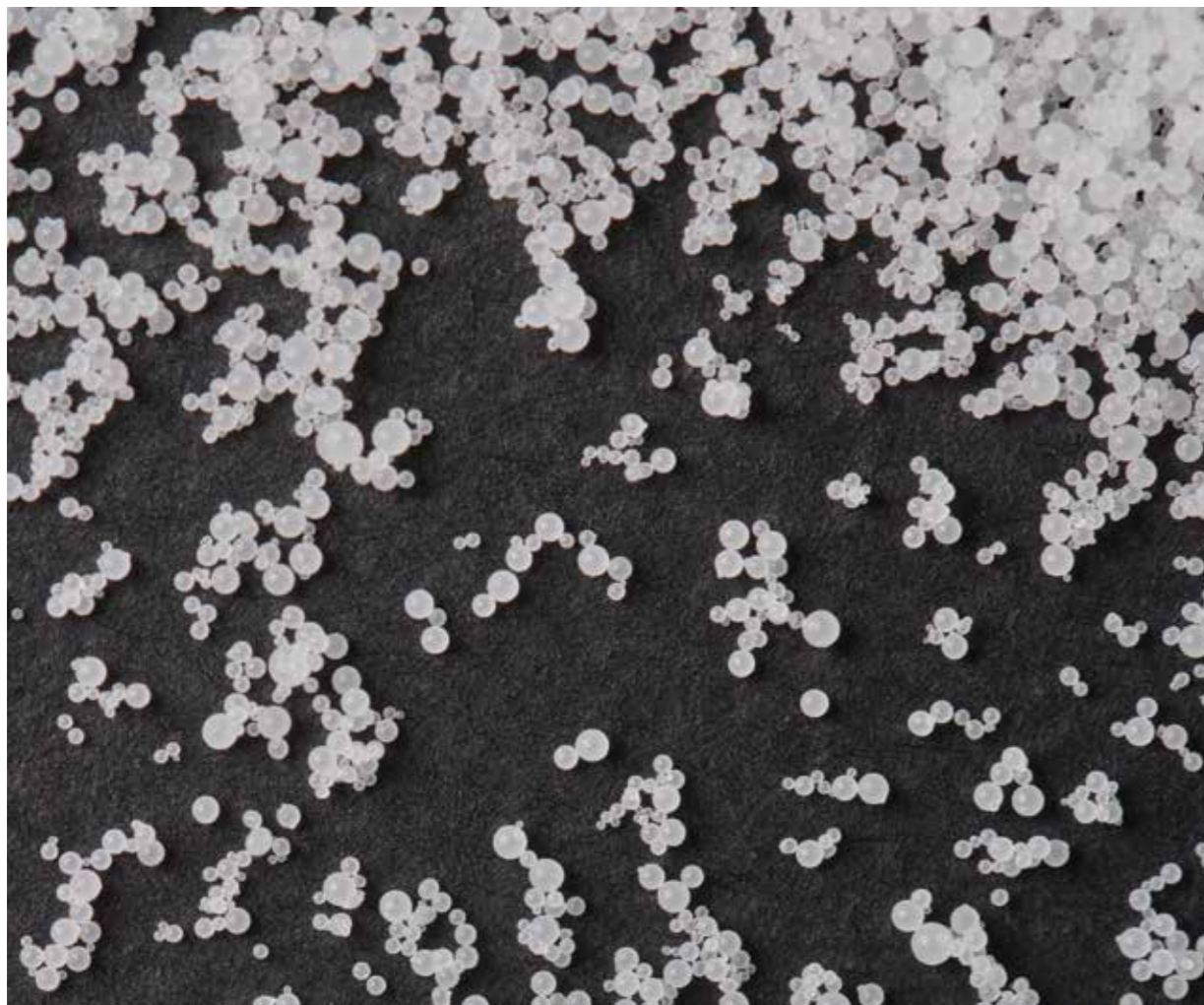

ORBIT 3Rs



Environmentally sustainable surfaces

Orbit 3Rs is one of the latest innovations created by RAK Ceramics R&D laboratories which produces sustainable and high performance tiles that contribute to the reduce, reuse and recycle concept. The tiles are manufactured with up to 95% recycled materials from wastes generated during the manufacturing process of ceramic tiles.

Orbit 3Rs tiles meet the architectural requirements of environmentally sustainable and durable products, making them ideal for new construction trends and tailoring private homes for both outdoor and indoor environments.



ABSOLUTE MATT



Extra matt, zero gloss surfaces

Absolute Matt is the most recent innovation developed by RAK Ceramics R&D laboratories, which takes the concept of matt to new heights by enabling tiles to achieve an extra-matt surface; with zero reflection and a completely non-glossy finish.

Absolute Matt enhances the tile's natural texture and durability, satisfying any design project's aesthetic and functional requirements.



LUCE



Translucent tiles for special environments

Light becomes a design tool in the hands of the designer with the Maximus Luce translucent slabs, which enrich any environment thanks to its backlighting technology. It is an absolute novelty that will inspire creativity.

With its varied graphics and colours inspired by the most precious marbles and onyx, plus its exceptional feature of transmitting light through, Luce is the perfect solution for sophisticated commercial and residential applications.



We play our role for a better environment and society

Sustainability in every sphere of business is one of the main elements of RAK Ceramics' mission statement. The company is committed to practising environmental stewardship throughout its manufacturing chain – from product design and efficient operations processes – and to playing an active role in building a better community by enhancing the surrounding environment. Organisation's activities improve energy efficiency, reduce pollution, enhance biodiversity and improve the quality of life for both people in the communities it operates in and for its workforce. It recycles natural raw materials to help conserve natural resources and adopts clean development mechanism (cdm) projects to reduce carbon emissions during the manufacturing process.

RAK Ceramics is the first ceramics manufacturing company in its region to produce a global reporting initiative (gri) sustainability and corporate social responsibility (csr) report, based on the latest gri-gr4 guidelines. RAK Ceramics is a founding member of Emirates Green Building Council, which supports the development of sustainable buildings in the UAE.

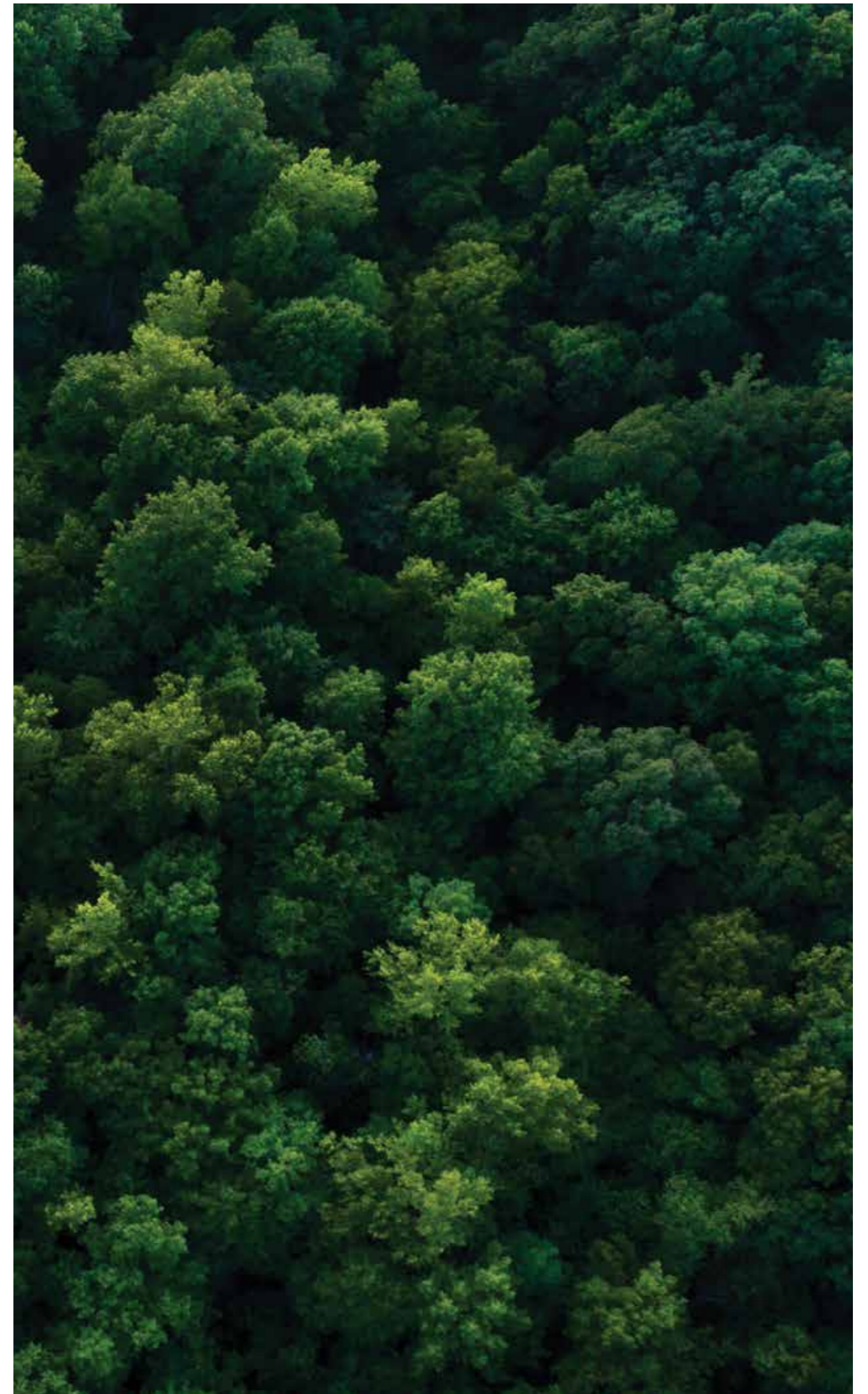



Quality makes us different

RAK Ceramics was the first company in the United Arab Emirates to be awarded with ISO 9001 certification by internationally recognised UK certification body “CICS” (Ceramic Research Institute Certification Scheme) for ceramics tiles and sanitary wares. Bureau Veritas Certifications verified the implementation of RAK Ceramics’ quality management system and certified the company in compliance with the requirements of ISO 9001:2015 with the scope covering the design, development, production and supply of ceramics and porcelain floor and wall tiles, slabs and vitreous china sanitary wares.

Bureau Veritas Certifications also certified RAK Ceramics for **ISO 14001:2015 Environmental Management System.**

RAK Ceramics manufactures ceramic tiles according to the latest version of ISO 13006 and/or EN 1441 standards with equivalent ANSI A137.1 American national standard specifications for ceramics tiles. Its Testing Laboratory is operating in accordance to ISO/IEC 17025 accredited by NATA (National Association of Testing Authorities, Australia). Being a corporate member of EGBC (Emirates Green Building Council), RAK Ceramics supports the promotion and development of sustainable buildings in United Arab Emirates.

The world's leading ceramics lifestyle solution provider

RAK Ceramics helps architects and interior designers create icons and build marvels. It provides sustainable materials that inspire ideas, shapes and hues designed to freely express any style. Unique and inspiring products that realistically resemble natural materials, with unlimited choice.

RAK Ceramics gives porcelain perfection and limitless imagination. Its passion and expertise combined with a careful attention to detail enables it to provide designers and end users with a wide range of integrated ceramics solutions, allowing them freedom to be creative and plenty of room for imagination.

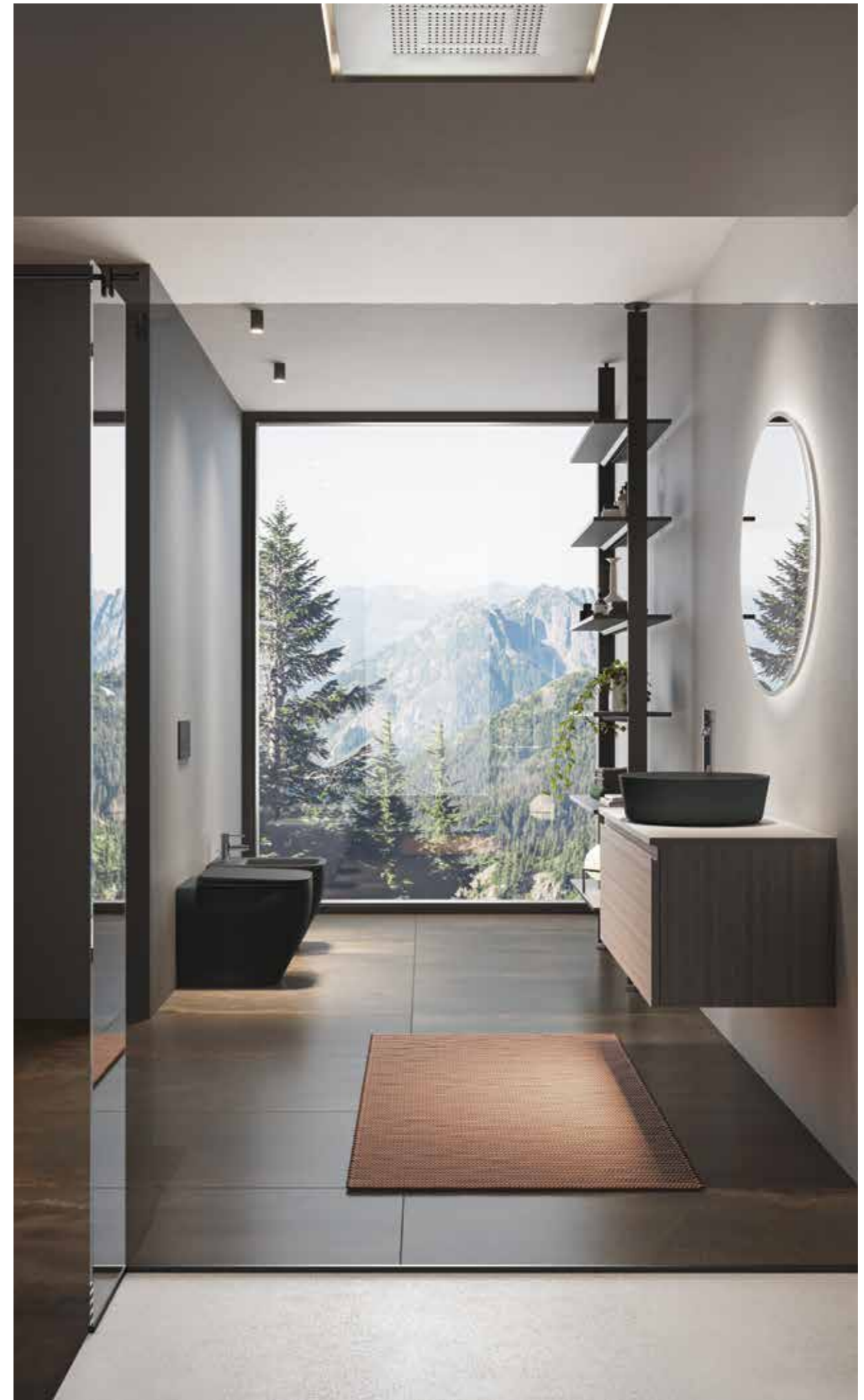



A track record of expertise

RAK Ceramics' products feature in some of the most iconic buildings in the world. From the Burj Al Arab, Atlantis on The Palm and Ferrari World, to Dubai Duty Free, Wembley Stadium, The O2 Arena, Mercedes Benz Showrooms, Airports, Residential Developments and Shopping Malls all over the world.



Marble

Design your luxury interiors with a timeless charm

A wide and varied range of collections inspired by the elegance of marble to offer hundreds of solutions for residential areas, hospitality industry and business places. Revised classy marble and granite patterns displaying elegant veins which remodel your spaces, creating sophisticated ambiances. When you choose a Marble looking tile collection, you choose the timeless beauty of one of the finest materials in nature, combining it with all the advantages of porcelain and ceramic tiles in terms of performance, durability, ease of laying and maintenance.

Versatile and simply beautiful, the Maximus slab revolutionises the design and architecture world by opening up new perspectives in tiles application that were previously unimaginable. All the continuous surfaces are designed for any type of application: floor and walls, cladding, furnishing, countertops and provide creative flexibility and high technical and aesthetic performances.

WALLS AND FACADE

COUNTERTOP SURFACES

FURNITURE

FLOOR

Amani Marble



Amani Marble

PORCELAIN TILES

Polished • Rectified • Smooth

MAXIMUS
MEGA SLAB



SIZES

120x240 cm
>|< 9 mm

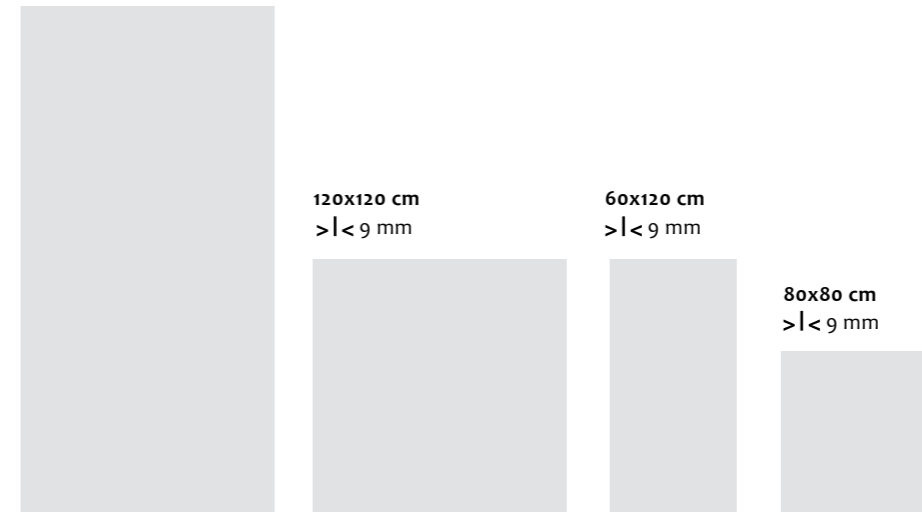

amani marble light grey



amani marble dark grey

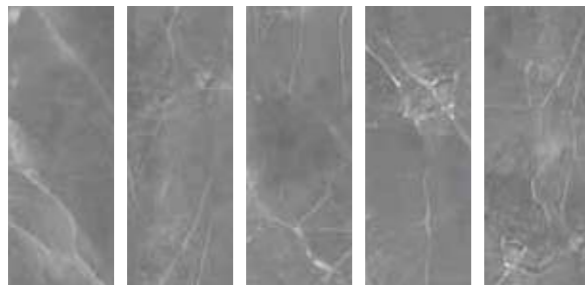

amani marble light grey variations
120x240 and 60x120

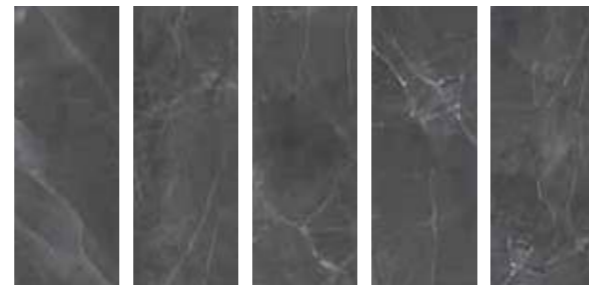

amani marble dark grey variations
120x240 and 60x120

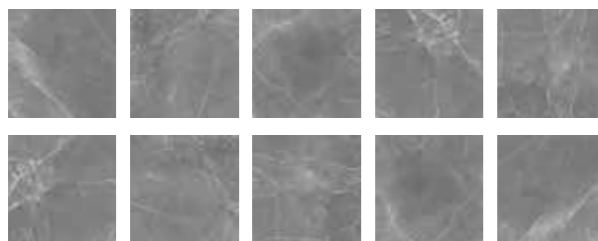

amani marble light grey variations
120x120

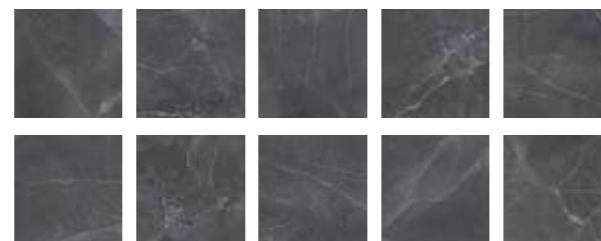

amani marble dark grey variations
120x120 and 80x80



polished			polished		
Name	Code	Size(CM)	Name	Code	Size(CM)
amani marble light grey	AGB46AMMBLIGZHSC3P	120x240	amani marble dark grey	AGB46AMMBDKGZHSC3P	120x240
amani marble light grey	AGB22AMMBLIGZHSC3P	120x120	amani marble dark grey	AGB22AMMBDKGZHSC3P	120x120
amani marble light grey	AGB12AMMBLIGZHSS5P	60x120	amani marble dark grey	AGB12AMMBDKGZHSS5P	60x120
-	-	-	amani marble dark grey	Ao5GAMMB-DKG-HoXoP	80x80

Sizes (cm)	Thickness (mm)	Pieces X	M² X	Kg X	X Eu. Pallet	M² X Eu. Pallet	kg X Eu. Pallet
120x240	9	1	2.88	60	15	43.20	995
120x120	9	2	2.88	60	22	63.36	1320
60x120	9	2	1.44	29	30	43.20	891
80x80	9	2	1.28	27	40	51.20	1100

Bahia Wave



Bahia Wave

PORCELAIN TILES

Polished • Rectified • Smooth

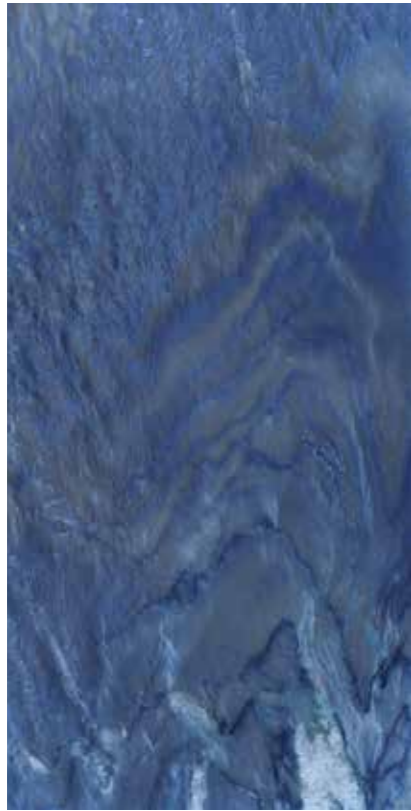

bahia wave blue

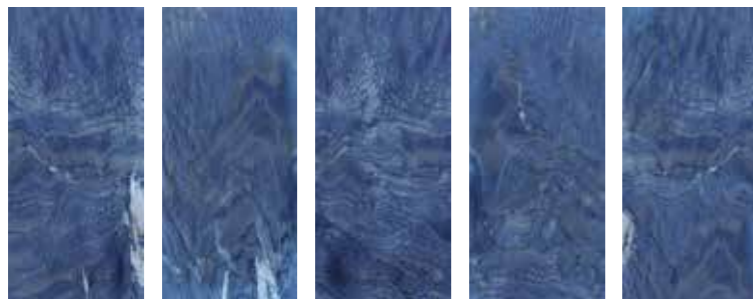

bahia wave blue variations
120x240 and 60x120



bahia wave blue variations
120x120

MAXIMUS
MEGA SLAB



SIZES

120x240 cm

>|< 9 mm

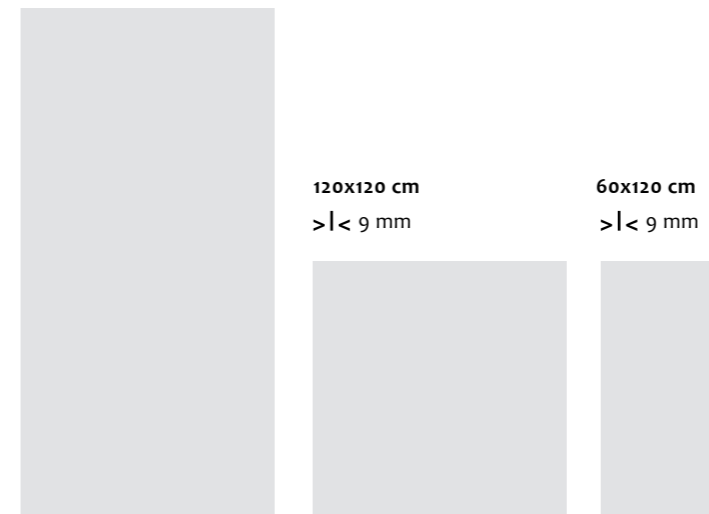

polished		
Name	Code	Size(CM)
bahia wave blue	AGB46BHWEBLEZHSC3P	120x240
bahia wave blue	AGB22BHWEBLEZHSC3P	120x120
bahia wave blue	AGB12BHWEBLEZHSS5P	60x120

Sizes (cm)	Thickness (mm)	Pieces X	M² X	Kg X	X Eu. Pallet	M² X Eu. Pallet	kg X Eu. Pallet
120x240	9	1	2.88	60	15	43.20	995
120x120	9	2	2.88	60	22	63.36	1320
60x120	9	2	1.44	29	30	43.20	891

Black Beauty

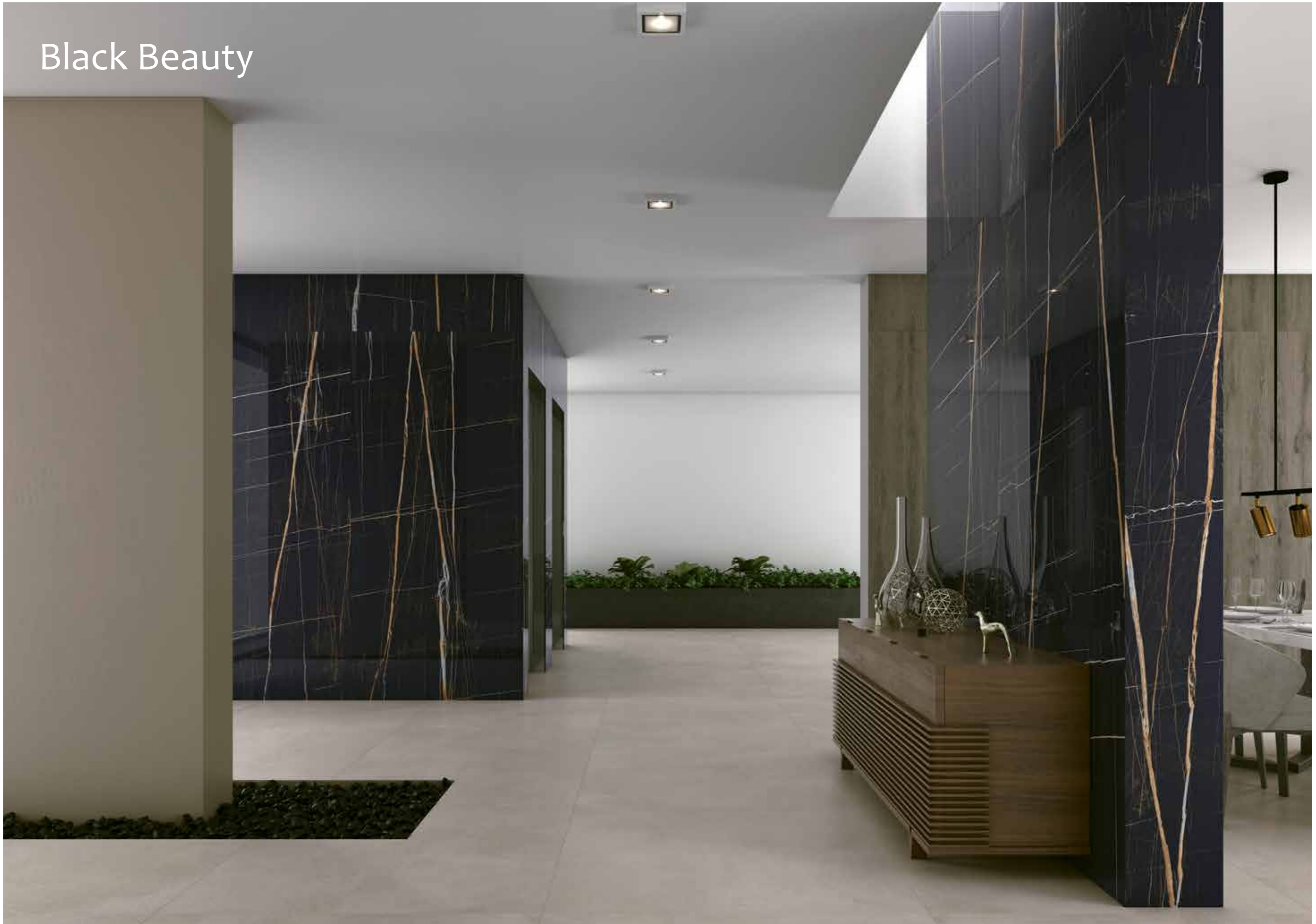

Black Beauty

PORCELAIN TILES

Polished • Rectified • Smooth



black beauty



black beauty variations
120x240 and 60x120



black beauty variations
120x120



MAXIMUS
MEGA SLAB



SIZES

120x240 cm

>|< 9 mm

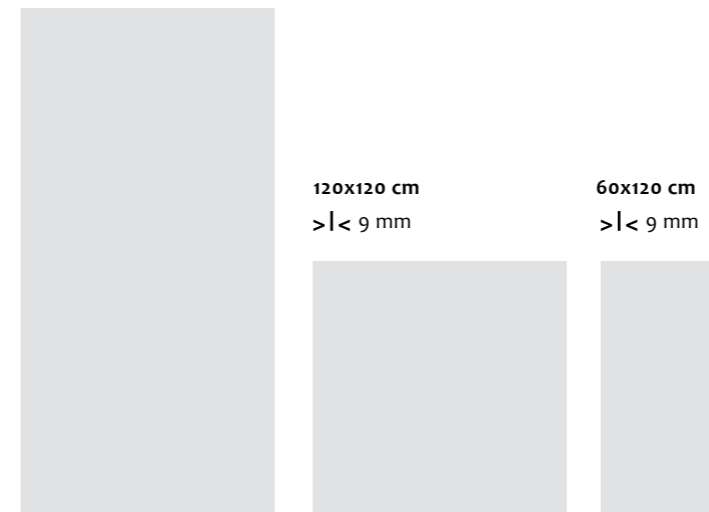

Available as a countertop – see page 182.



polished		
Name	Code	Size(CM)
black beauty	AGB46BBKBNEOZHSC3P	120x240
black beauty	AGB22BBKBNEOZHSC3P	120x120
black beauty	At2GBKB-NEO-GoX5P	60x120

Sizes (cm)	Thickness (mm)	Pieces X	M² X	Kg X	X Eu. Pallet	M² X Eu. Pallet	kg X Eu. Pallet
120x240	9	1	2.88	60	15	43.20	995
120x120	9	2	2.88	60	22	63.36	1320
60x120	9	2	1.44	29	30	43.20	891

Blu Del Belgio

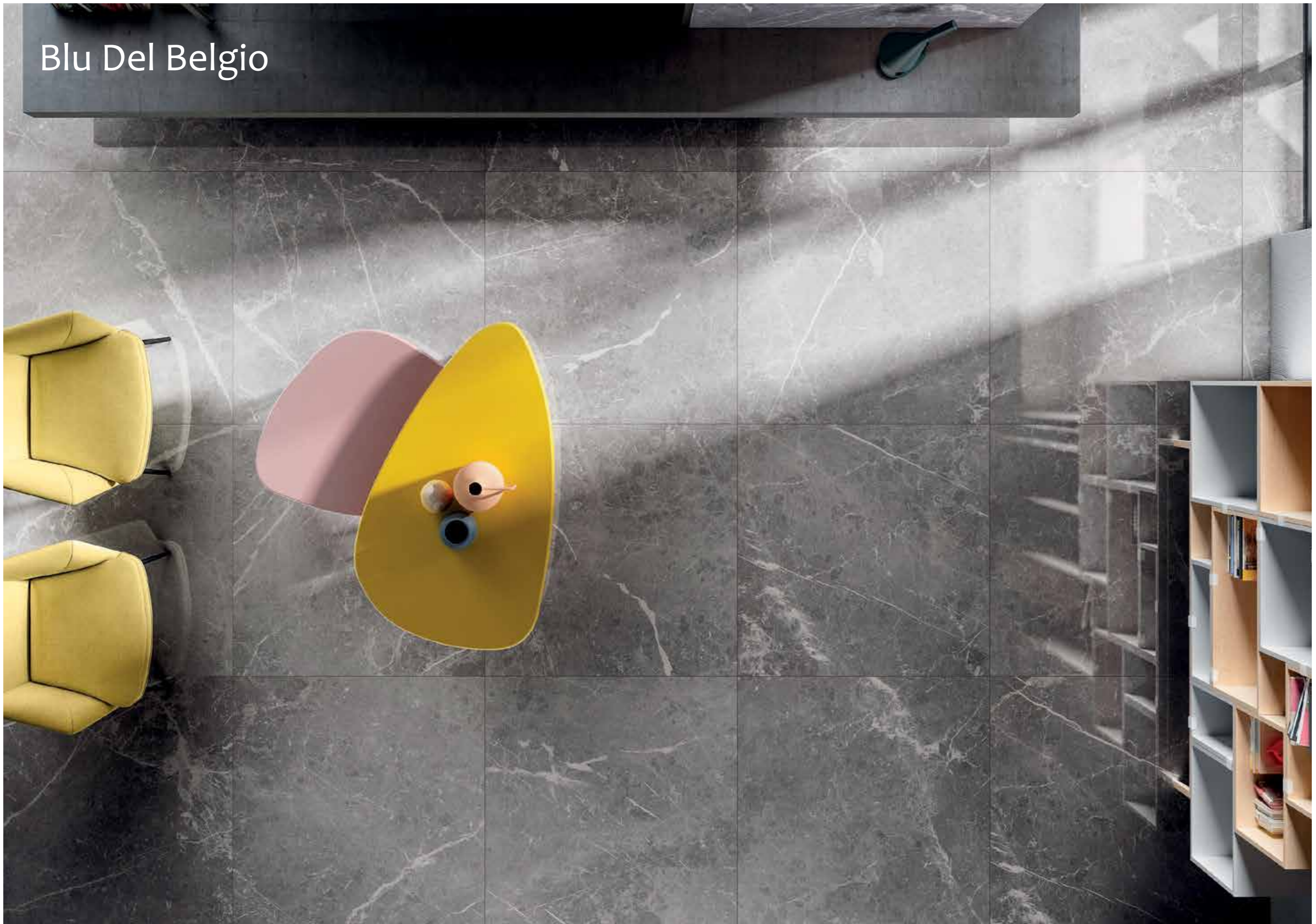

Blu Del Belgio

PORCELAIN TILES

Polished • Rectified • Smooth

MAXIMUS
MEGA SLAB



SIZES

135x305 cm*

>| < 14.5 mm

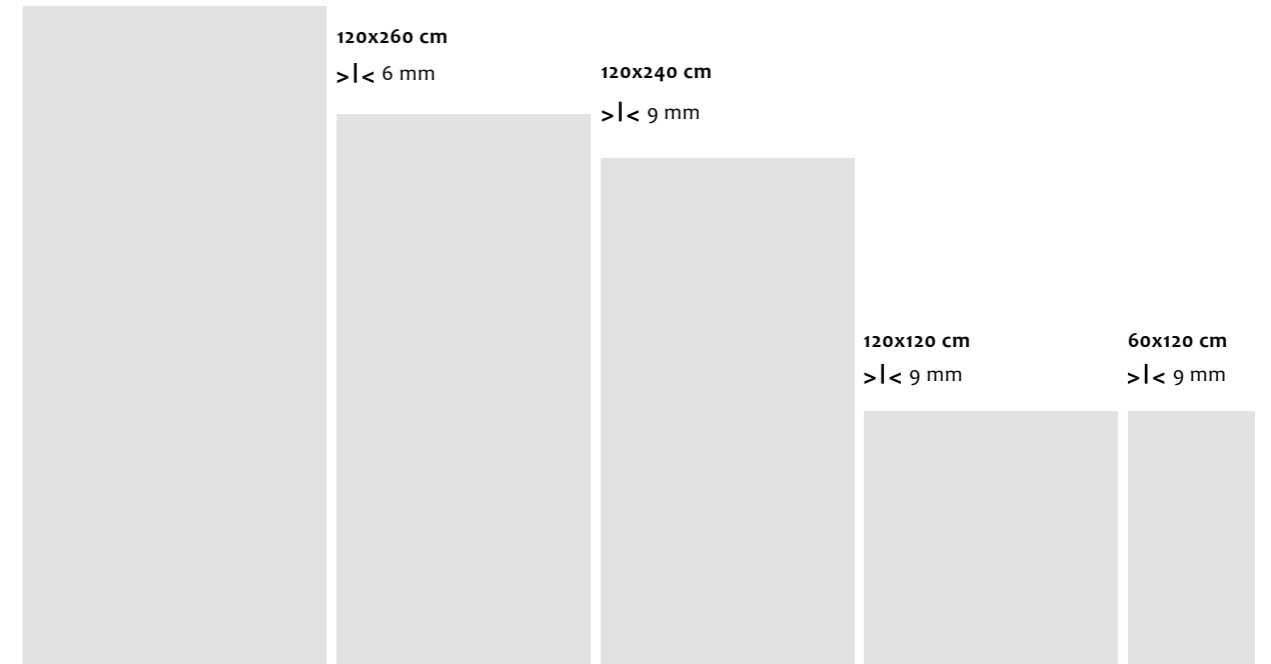

*Available in clay only. Available as a countertop – see page 182.



blu del belgio blue

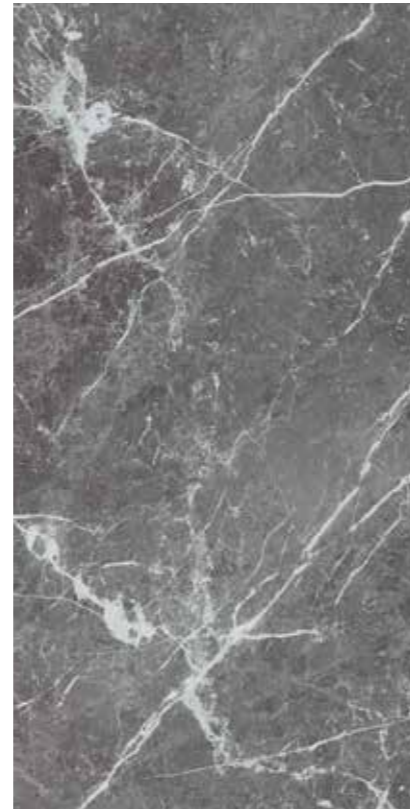

blu del belgio clay

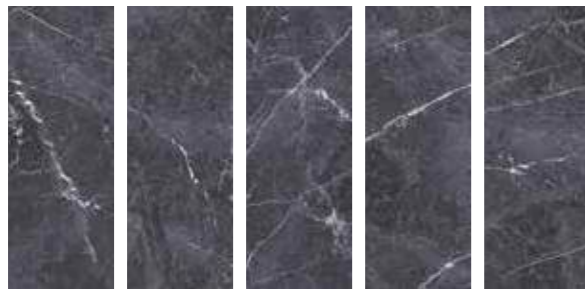

blu del belgio blue variations
135x305, 120x260, 120x240 and 60x120

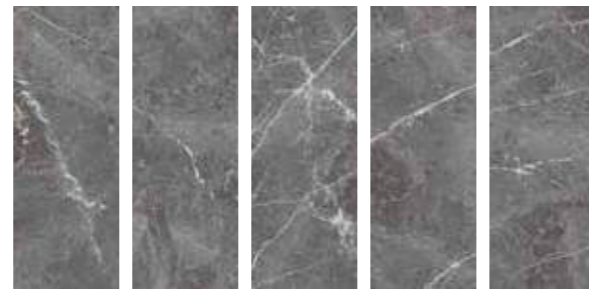

blu del belgio clay variations
135x305, 120x260, 120x240 and 60x120

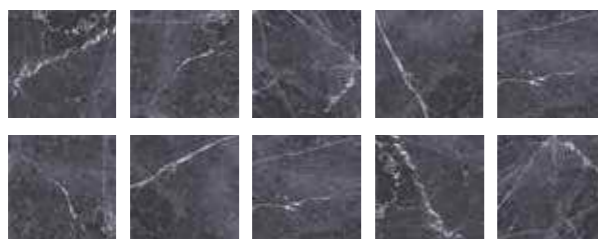

blu del belgio blue variations
120x120

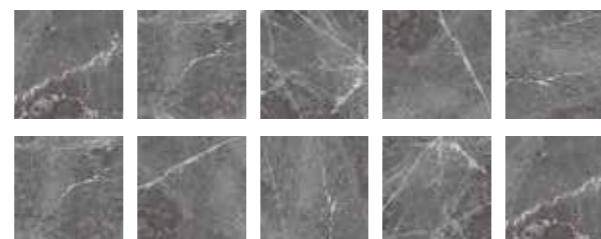

blu del belgio clay variations
120x120

polished			polished		
Name	Code	Size(CM)	Name	Code	Size(CM)
blu del belgio blue	A83GZBLB-BLo.GoC2P	135x305	blu del belgio clay	A83GZBLB-CLo.GoC2P	135x305
blu del belgio blue	A62GZBLB-BLo.GoC6P	120x260	blu del belgio clay	A62GZBLB-CLo.GoC6P	120x260
blu del belgio blue	Al46GBLB-BLo.GoC3P	120x240	blu del belgio clay	Al46GBLB-CLo.GoC3P	120x240
blu del belgio blue	Al22GBLB-BLo.GoC3P	120x120	blu del belgio clay	Al22GBLB-CLo.GoC3P	120x120
blu del belgio blue	AGB12ZBLBLEZGSS5P	60x120	blu del belgio clay	AGB12ZBLBCLAZGSS5P	60x120

Sizes (cm)	Thickness (mm)	Pieces X	M² X	Kg X	X Eu. Pallet	M² X Eu. Pallet	kg X Eu. Pallet
135x305	14.5	1	4.12	160	10	41.20	1600
120x260	6	1	3.12	48	20	62.40	960
120x240	9	1	2.88	60	15	43.20	995
120x120	9	2	2.88	60	22	63.36	1320
60x120	9	2	1.44	29	30	43.20	891

Breccia

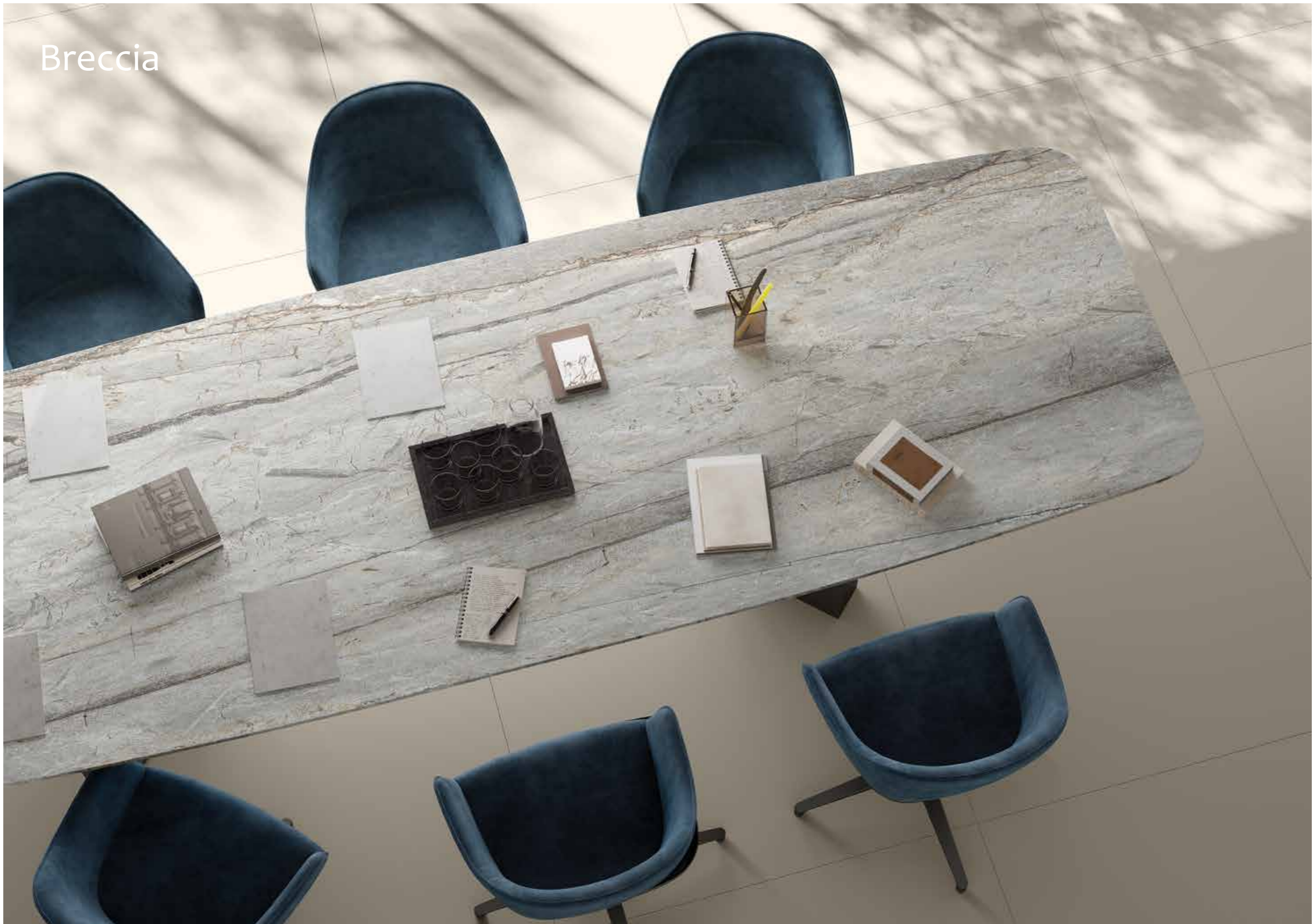

Breccia

PORCELAIN TILES

Polished / Matt / Honed • Rectified • Smooth



SIZES

120x260 cm

>|< 6 mm

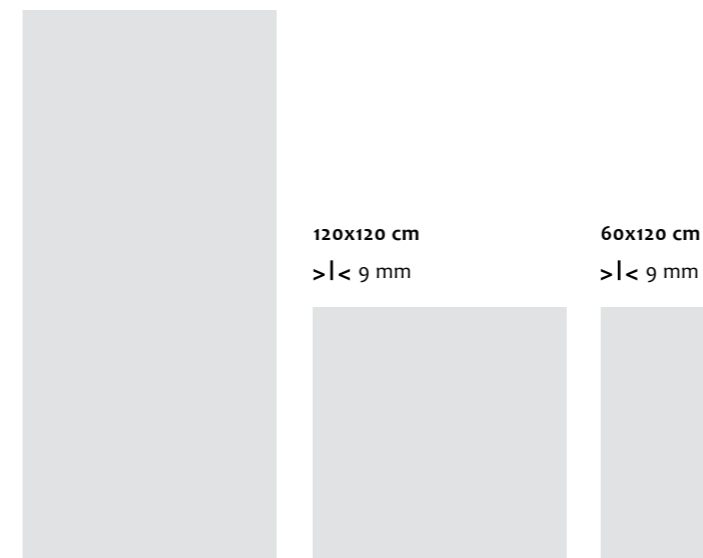

breccia adige grey



breccia daino beige



breccia adige grey variations
120x260 and 60x120



breccia daino beige variations
120x260 and 60x120



breccia adige grey variations
120x120

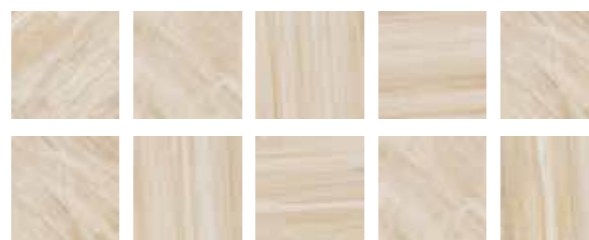

breccia daino beige variations
120x120

FINISHES



polished



matt



honed

Name	polished		matt		honed	
	Code	Size(CM)	Code	Size(CM)	Code	Size(CM)
breccia adige grey	A62GBRAE-GRY.NoX6P	120x260	-	-	A62GBRAE-GRY.OoX6P	120x260
breccia adige grey	A22GBRAE-GRY.NoX5P	120x120	A22GBRAE-GRY-MoX5R	120x120	-	-
breccia adige grey	A12GBRAE-GRY.NoX5P	60x120	A12GBRAE-GRY-MoX5R	60x120	-	-
breccia daino beige	A62GBRDA-BEE.NoX6P	120x260	-	-	A62GBRDA-BEE.OoX6P	120x260
breccia daino beige	A22GBRDA-BEE.NoX5P	120x120	A22GBRDA-BEE-MoX5R	120x120	-	-
breccia daino beige	A12GBRDA-BEE.NoX5P	60x120	A12GBRDA-BEE-MoX5R	60x120	-	-

Sizes (cm)	Thickness (mm)	Pieces X	M² X	Kg X	X Eu. Pallet	M² X Eu. Pallet	kg X Eu. Pallet
120x260	6	1	3.12	48	20	62.40	960
120x120	9	2	2.88	60	22	63.36	1320
60x120	9	2	1.44	29	30	43.20	891

Calacatta

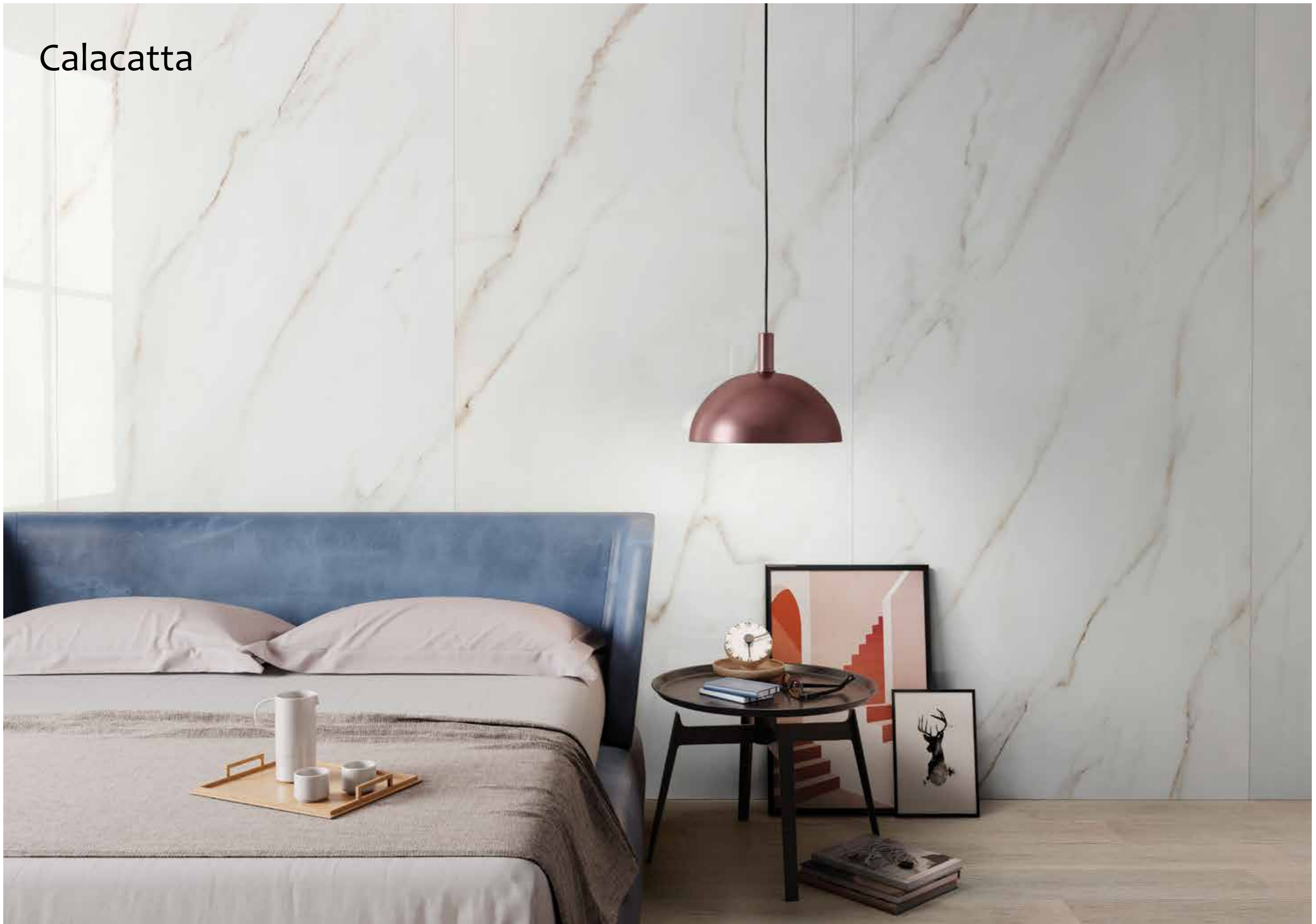

Calacatta

PORCELAIN TILES

Polished / Matt • Rectified • Smooth

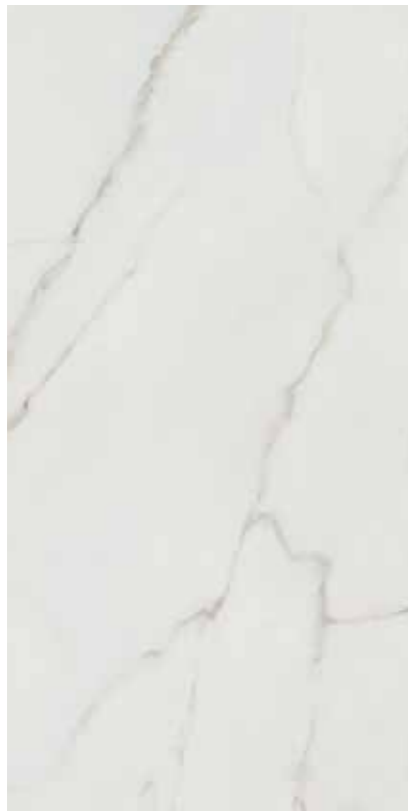

calacatta africa white



calacatta gold white

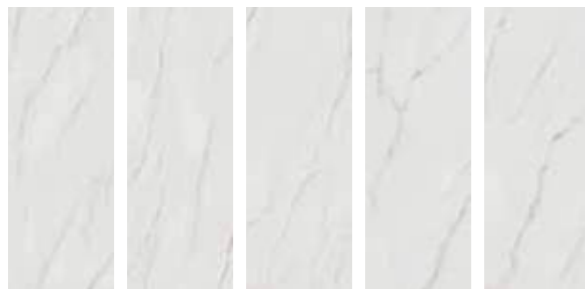

calacatta africa white variations
135x305, 120x260, 120x240 and 60x120



calacatta gold white variations
135x305, 120x260, 120x240 and 60x120

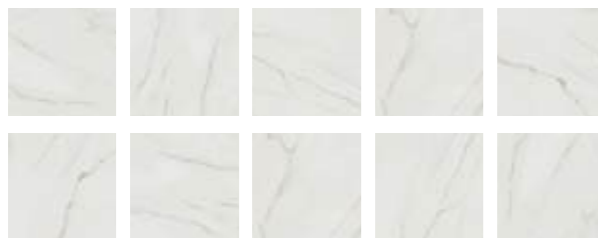

calacatta africa white variations
120x120



calacatta gold white variations
120x120 and 80x80

SIZES

135x305 cm*
>|< 14.5 mm

*Available in polished only.

Available as a countertop – see page 182.

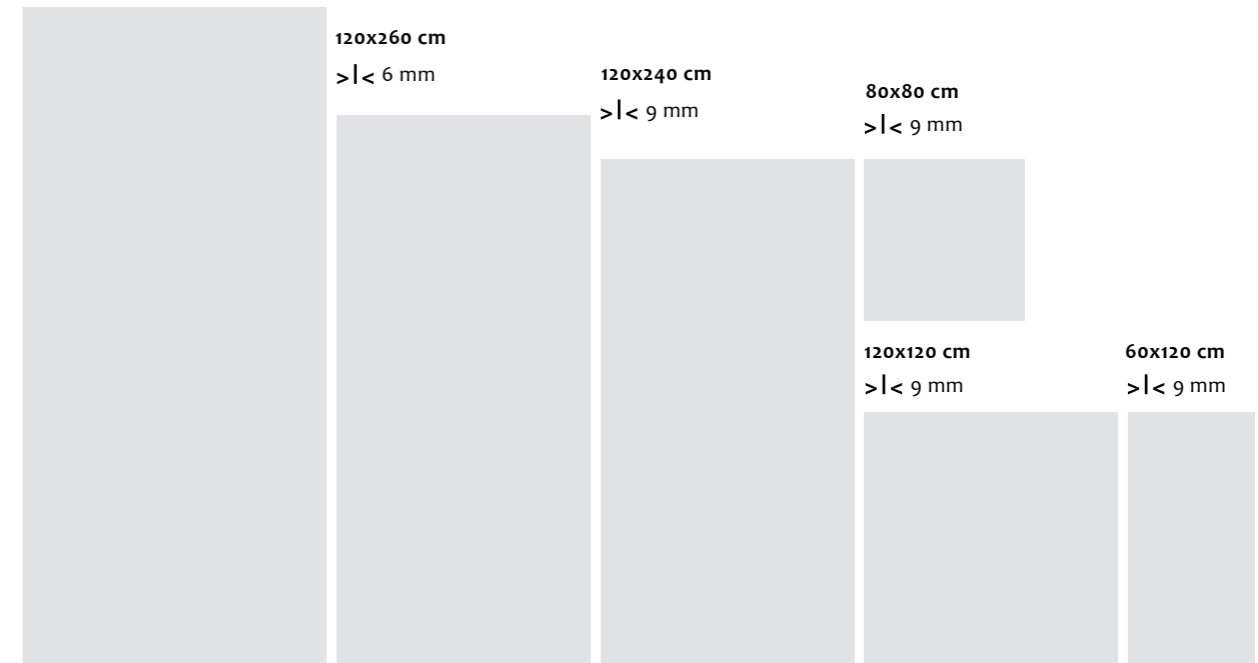

FINISHES



polished



matt

polished			matt	
Name	Code	Size(CM)	Code	Size(CM)
calacatta africa white	A83GCCAF-WHE.NoX2P	135x305	-	-
calacatta africa white	A62GCCAF-WHE.NoX6P	120x260	A62GCCAF-WHE.MoX6R	120x260
calacatta africa white	AGB46CCAFWHEZHSC3P	120x240	-	-
calacatta africa white	AGB22CCAFWHEZHSC3P	120x120	A22GCCAF-WHE.MoX5R	120x120
calacatta africa white	AGB12CCAFWHEZHSS5P	60x120	A12GCCAF-WHE.MoX5R	60x120
calacatta gold white	A83GCTAG-WHE.NoX2P	135x305	-	-
calacatta gold white	A62GCTAG-WHE.NoX6P	120x260	A62GCTAG-WHE.MoX6R	120x260
calacatta gold white	AGB46CTAGWHEZHSC3P	120x240	A46GCTAG-WHE.MoX5R	120x240
calacatta gold white	AGB22CTAGWHEZHSC3P	120x120	A22GCTAG-WHE.MoX5R	120x120
calacatta gold white	AGB12CTAGWHEZHSS5P	60x120	A12GCTAG-WHE.MoX5R	60x120
calacatta gold white	A05GCTAG-WHE-GoX0P	80x80	A05GCTAG-WHE-MoX0R	80x80

Sizes (cm)	Thickness (mm)	Pieces X	M² X	Kg X	X Eu. Pallet	M² X Eu. Pallet	kg X Eu. Pallet
135x305	14.5	1	4.12	160	10	41.20	1600
120x260	6	1	3.12	48	20	62.40	960
120x240	9	1	2.88	60	15	43.20	900
120x120	9	2	2.88	60	22	63.36	1320
60x120	9	2	1.44	29	30	43.20	891
80x80	9	2	1.28	27	40	51.20	1100

Classic Carrara

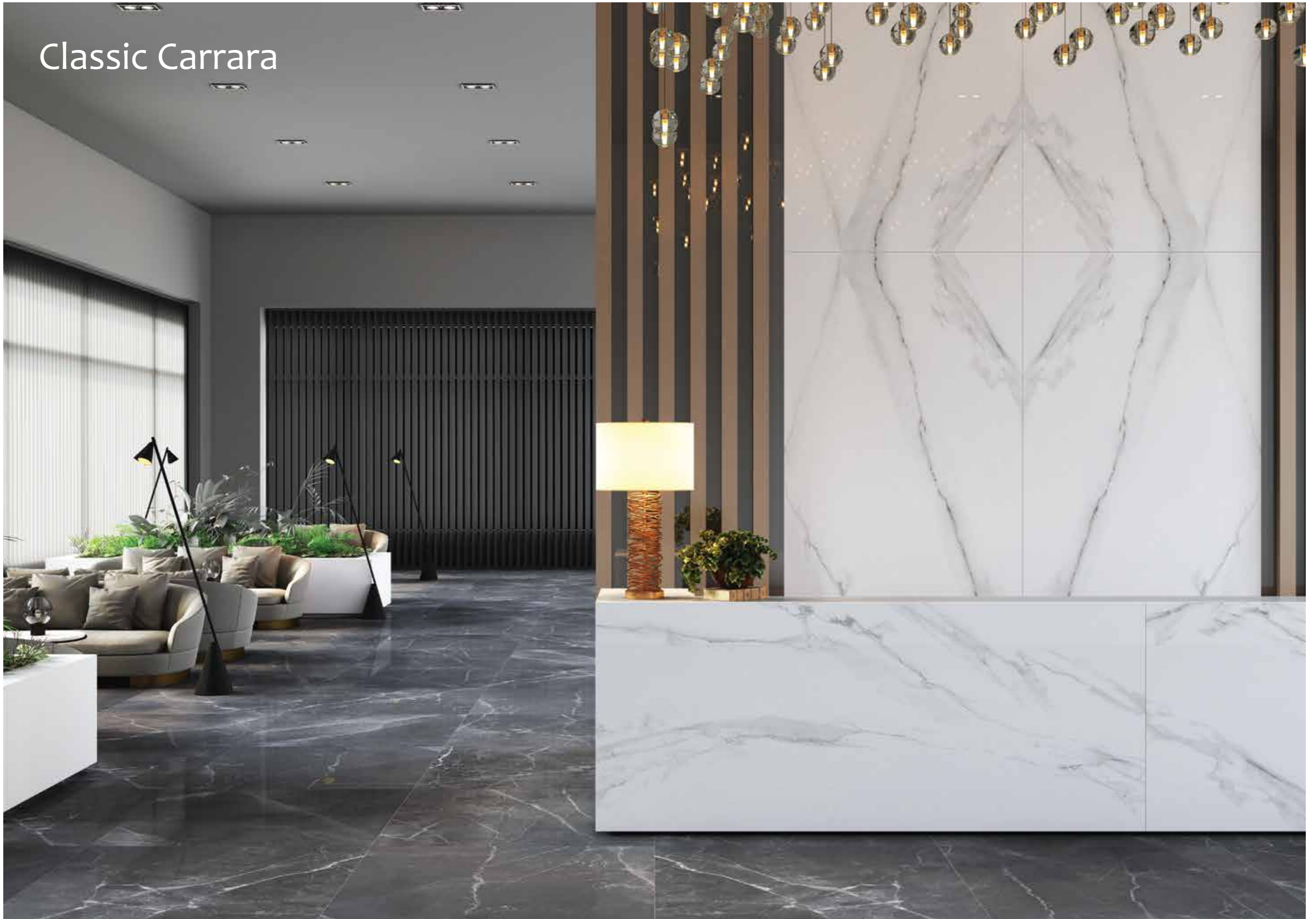

Classic Carrara

PORCELAIN TILES

Polished / Matt • Rectified • Smooth



SIZES

135x305 cm*
>|< 14.5 mm

*Available as a countertop – see page 182.

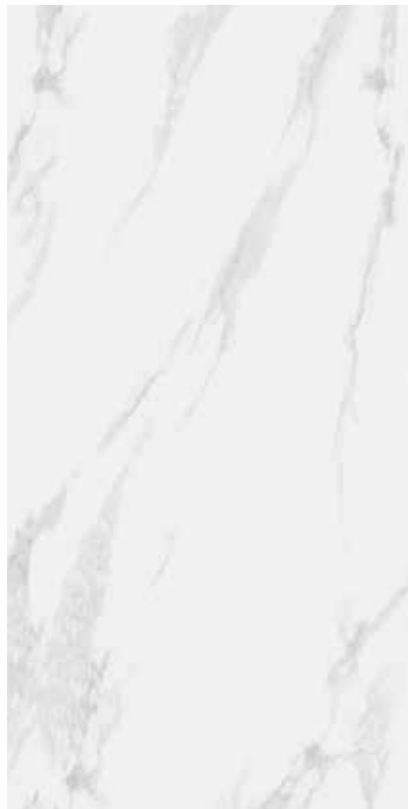
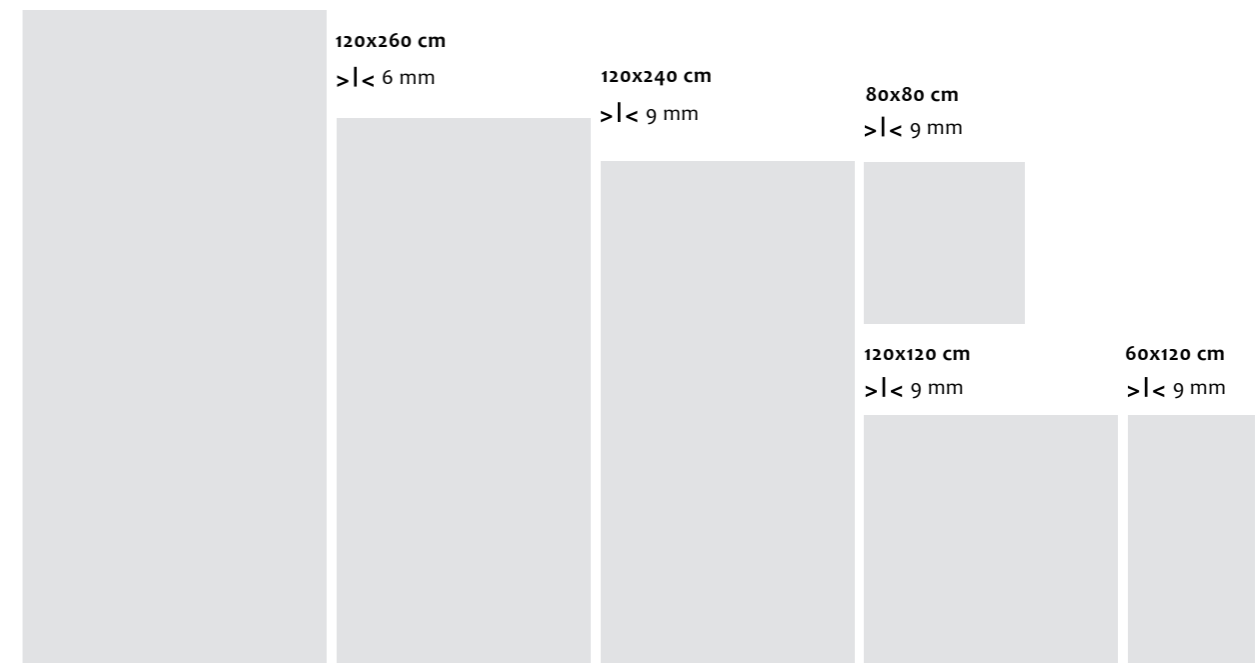

classic carrara grey

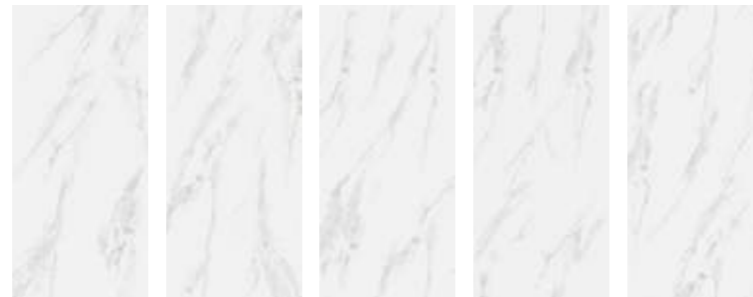

classic carrara grey variations
135x305, 120x260, 120x240 and 60x120

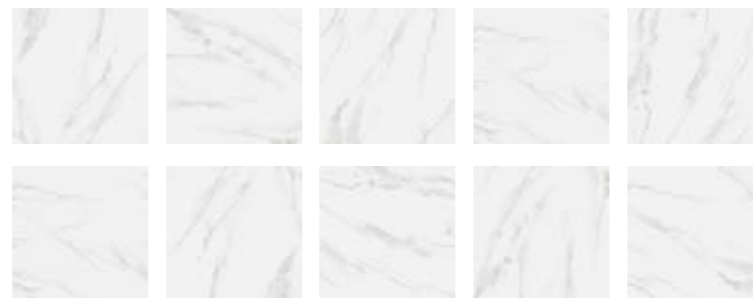

classic carrara grey variations
120x120 and 80x80

FINISHES



polished



matt



polished		matt		
Name	Code	Size(CM)	Code	Size(CM)
classic carrara grey	A83GZCRR-GYo.GoC2P	135x305	A83GZCRR-GYo.GoC2P	135x305
classic carrara grey	A62GZCRR-GYo.GoC6P	120x260	A62GZCRR-GRY-MoX6R	120x260
classic carrara grey	A146ZCRR-GYo.GoC3P	120x240	-	-
classic carrara grey	A122GZCRR-GY.GoC3P	120x120	A22GZCRR-GRY-MoX5R	120x120
classic carrara grey	AGB12ZCRRGRYZGSS5P	60x120	A12GZCRR-GRY-MoX5R	60x120
classic carrara grey	A05GZCRR-GRY-GoXoP	80x80	A05GZCRR-GRY-MoXoR	80x80

Sizes (cm)	Thickness (mm)	Pieces X	M² X	Kg X	X Eu. Pallet	M² X Eu. Pallet	kg X Eu. Pallet
135x305	14.5	1	4.12	160	10	41.20	1600
120x260	6	1	3.12	48	20	62.40	960
120x240	9	1	2.88	60	15	43.20	995
120x120	9	2	2.88	60	22	63.36	1320
60x120	9	2	1.44	29	30	43.20	891
80x80	9	2	1.28	27	40	51.20	1100

Luce



MARBLE

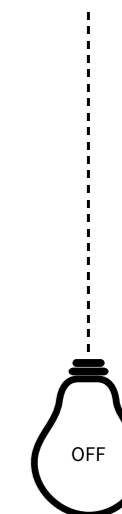
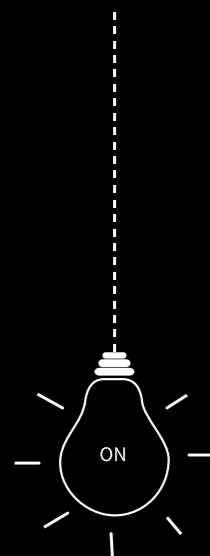

LUCE

Light becomes a design tool in the hands of the designer and through elegant surfaces it enriches environments, making them magical.

This is what makes the new Luce slabs a stunning centrepiece for your design concept with amazing backlighting technology. An absolute novelty that will inspire your creativity.

Seven different graphics and colours in marble and onyx effect, that replicate the natural ability of the stones to filter light.

Can be used in hotels, restaurants, offices, shops and sophisticated residential environments. Light up your projects with Luce.

Luce

PORCELAIN TILES

Polished • Rectified • Smooth

SIGNATURE
COLLECTION



SIZES

120x260 cm

>|< 6 mm



luce onyx white



luce onyx harlequin



luce onyx green jade



luce bahia azul



luce onyx ivory



luce onyx arco red



luce marble white



polished		
Name	Code	Size(CM)
luce onyx white	ATB62LUCEONYZHSC6P	120x260
luce onyx harlequin	ATB62LUCEOHNZHSC6P	120x260
luce onyx green jade	A62GLUCE-OGJ.NoX6P	120x260
luce bahia azul	ATB62LUCEBAZZHSC6P	120x260
luce onyx ivory	ATB62LUCEOIVZHSC6P	120x260
luce onyx arco red	ATB62LUCEOARZHSC6P	120x260
luce marble white	ATB62LUCEMARZHSC6P	120x260

Sizes (cm)	Thickness (mm)	Pieces X	M² X	Kg X	X Eu. Pallet	M² X Eu. Pallet	Kg X Eu. Pallet
120x260	6	1	3.12	48	20	62.40	960

Medicea Marble



Medicea Marble

PORCELAIN TILES

Polished / Matt • Rectified • Smooth



SIZES

135x305 cm*
>|< 14.5 mm

*Available in polished only.
Available as a countertop
- see page 182.

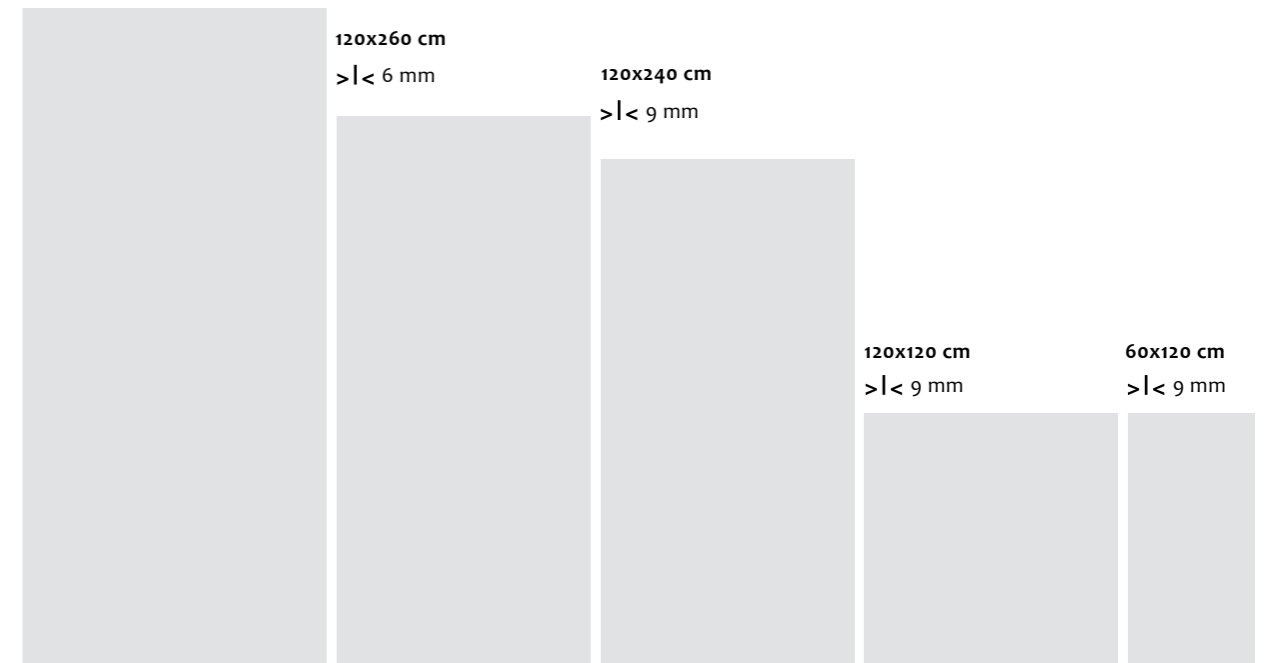

Sizes (cm)	Thickness (mm)	Pieces X	M ² X	Kg X	X Eu. Pallet	M ² X Eu. Pallet	Kg X Eu. Pallet
135x305	14.5	1	4.12	160	10	41.20	1600
120x260	6	1	3.12	48	20	62.40	960
120x240	9	1	2.88	60	15	43.20	995
120x120	9	2	2.88	60	22	63.36	1320
60x120	9	2	1.44	29	30	43.20	891

FINISHES

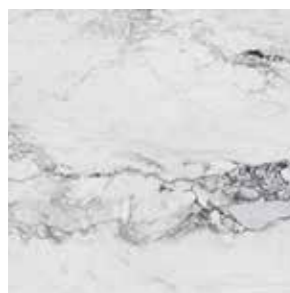

polished



matt

polished			matt		
Name	Code	Size(CM)	Code	Size(CM)	
medicea marble white	AGB83MDMBWHEZHSNLP	135x305	-	135x305	
medicea marble white	AGB62MDMBWHEZHSC6P	120x260	A62GMDMB-WHE-MoX6R	120x260	
medicea marble white	AGB46MDMBWHEZHSC3P	120x240	A46GMDMB-WHE-MoX5R	120x240	
medicea marble white	AGB22MDMBWHEZHSC3P	120x120	A22GMDMB-WHE-MoX5R	120x120	
medicea marble white	AGB12MDMBWHEZHSS5P	60x120	A12GMDMB-WHE-MoX5R	60x120	

Palissandro



Palissandro



PORCELAIN TILES

Polished / Matt / Honed • Rectified • Smooth



palissandro ivory variations
120x260 and 60x120

palissandro ivory

FINISHES



polished



matt



honed

polished		
Name	Code	Size(CM)
palissandro ivory	A62GZEBI-IVO.NoX6P	120x260
palissandro ivory	A12GZEBI-IVO.NoX5P	60x120

matt		
Name	Code	Size(CM)
palissandro ivory	A12GZEBI-IVO-MoX5R	60x120

honed		
Name	Code	Size(CM)
palissandro ivory	A62GZEBI-IVO.OoX6P	120x260

SIZES



120x260 cm

>| < 6 mm

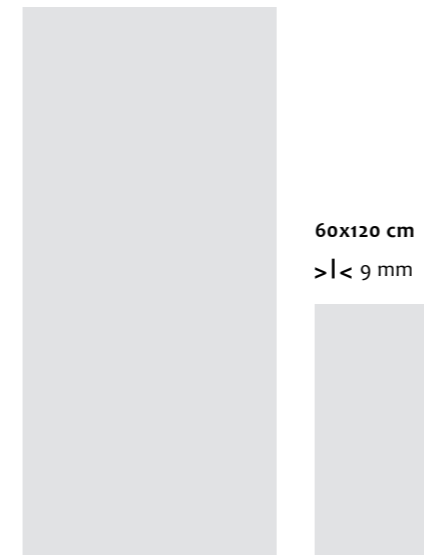

Sizes (cm)	Thickness (mm)	Pieces X	M² X	Kg X	X Eu. Pallet	M² X Eu. Pallet	kg X Eu. Pallet
120x260	6	1	3.12	48	20	62.40	960
60x120	9	2	1.44	29	30	43.20	891

Panda Marble

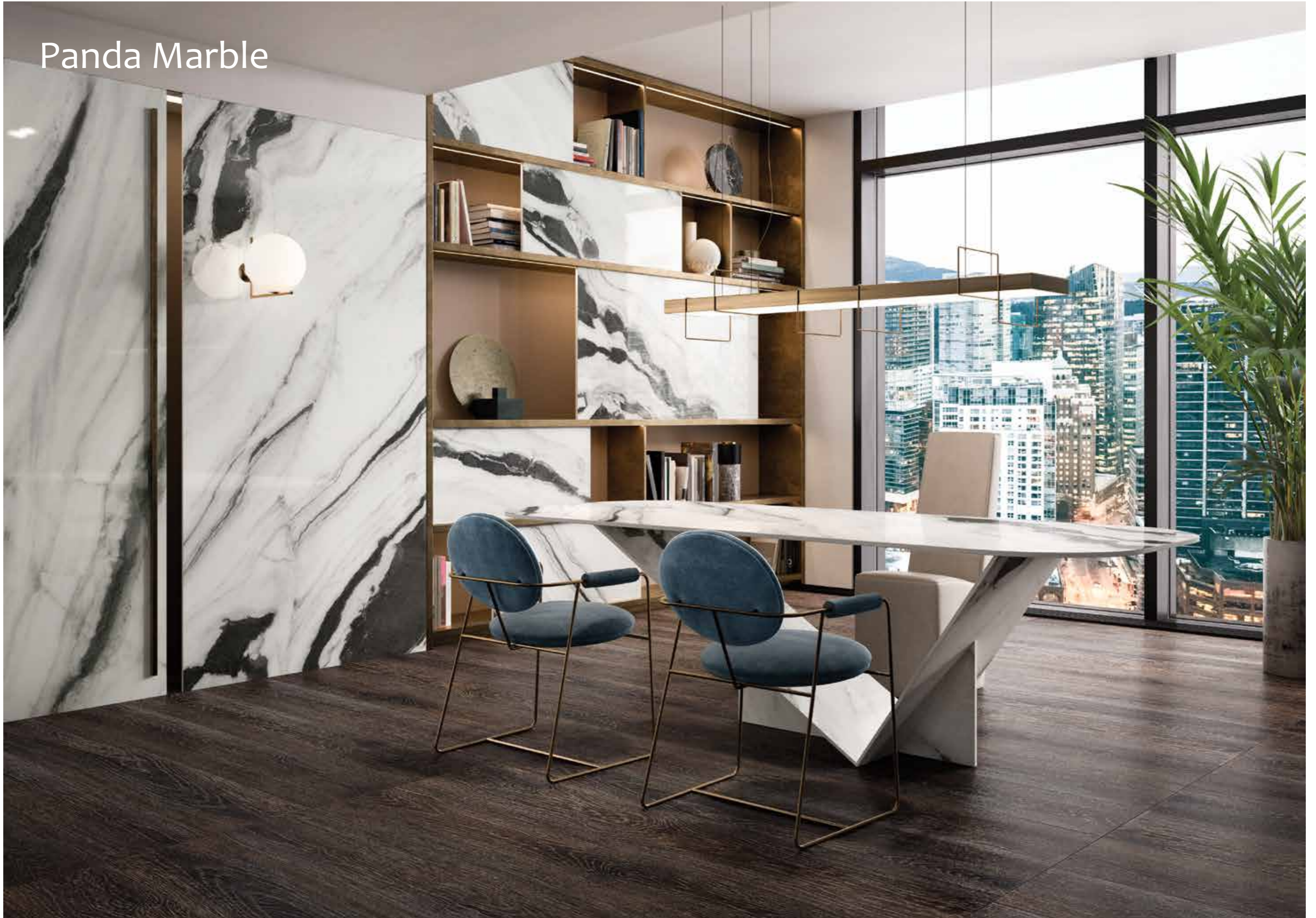

Panda Marble



PORCELAIN TILES

Polished / Matt / Honed • Rectified • Smooth



panda marble white

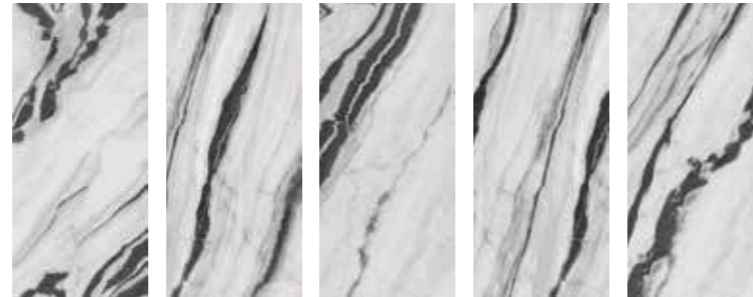

panda marble white variations
120x260, 120x240 and 60x120

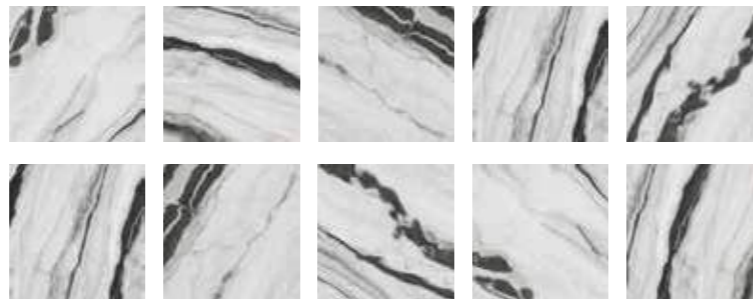

panda marble white variations
120x120

FINISHES

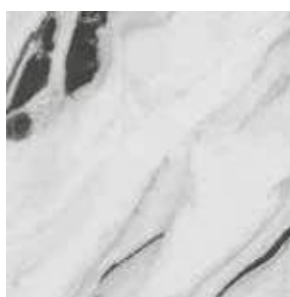

polished

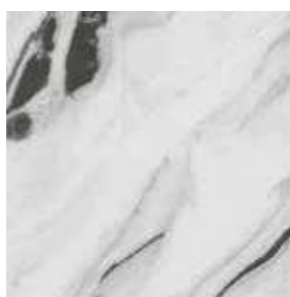

matt

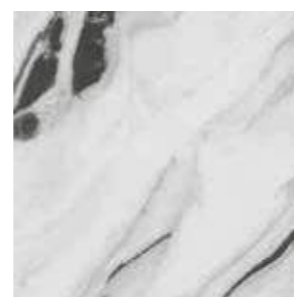

honed

polished		
Name	Code	Size(CM)
panda marble white	AGB62PDMBWHEZHSC6P	120x260
panda marble white	AGB46PDMBWHEZHSC3P	120x240
panda marble white	AGB22PDMBWHEZHSC3P	120x120
panda marble white	AGB12PDMBWHEZHSS5P	60x120

matt		
Name	Code	Size(CM)
panda marble white	A12GPDMB-WHE.MoX5R	60x120

honed		
Name	Code	Size(CM)
panda marble white	A62GPDMB-WHE.OoX6P	120x260

SIZES

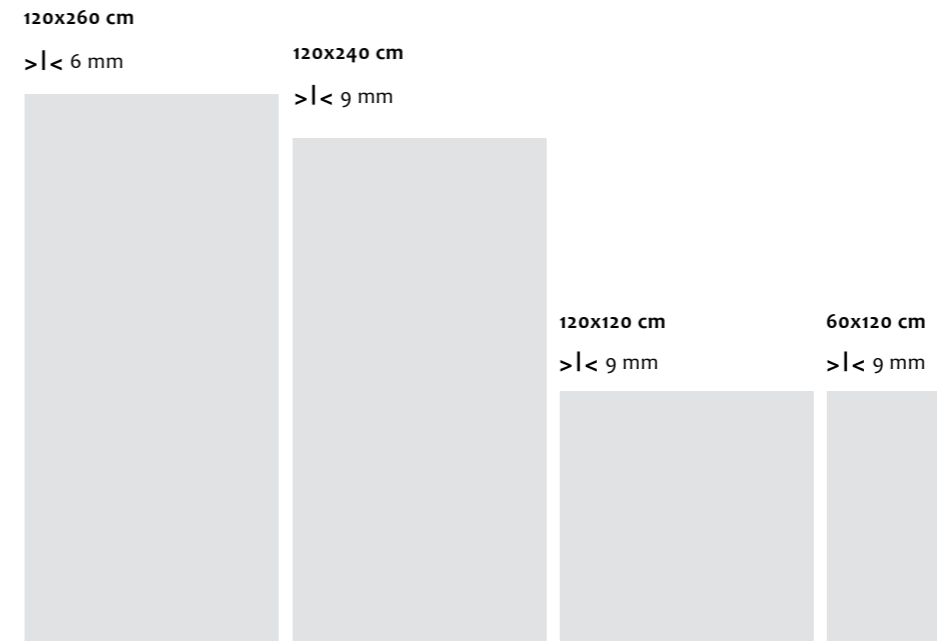

Sizes (cm)	Thickness (mm)	Pieces X	M² X	Kg X	X Eu. Pallet	M² X Eu. Pallet	kg X Eu. Pallet
120x260	6	1	3.12	48	20	62.40	960
120x240	9	1	2.88	60	15	43.20	995
120x120	9	2	2.88	60	22	63.36	1320
60x120	9	2	1.44	29	30	43.20	891

Preziosi

SIGNATURE
COLLECTION

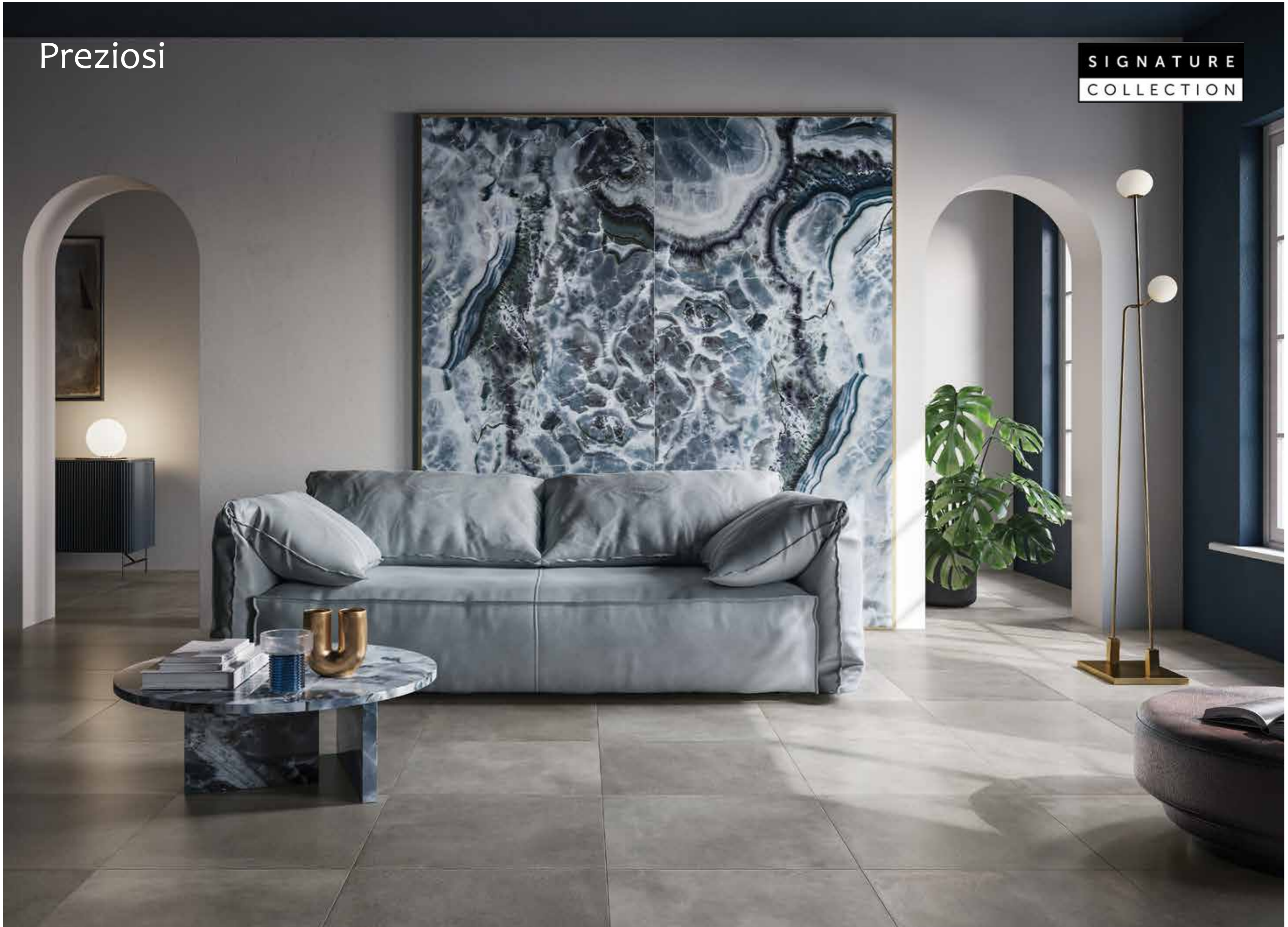

MARBLE

Preziosi

PORCELAIN TILES

Polished • Rectified • Smooth



SIZES

120x260 cm

>|< 6 mm

120x120 cm

>|< 9 mm

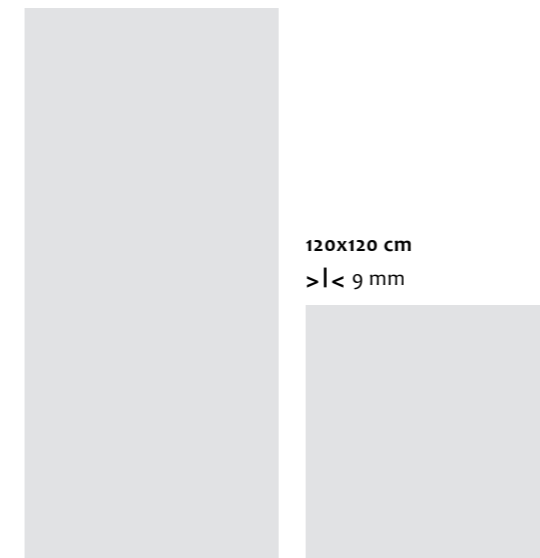

Sizes (cm)	Thickness (mm)	Pieces X	M² X	Kg X	X Eu. Pallet	M² X Eu. Pallet	kg X Eu. Pallet
120x260	6	1	3.12	48	20	62.40	960
120x120	9	2	2.88	60	22	63.36	1320

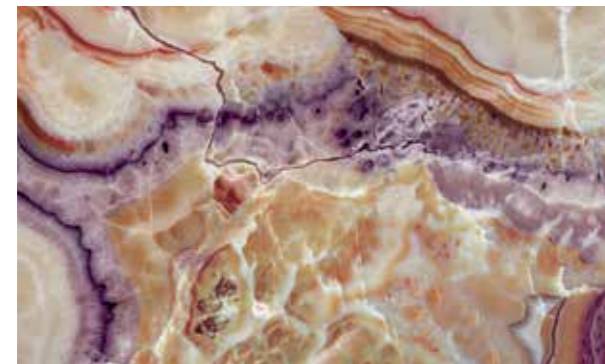

preziosi rio



preziosi pearl



preziosi green



preziosi rock

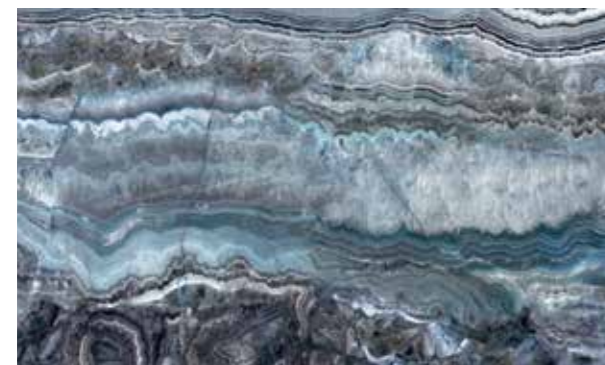

preziosi ocean

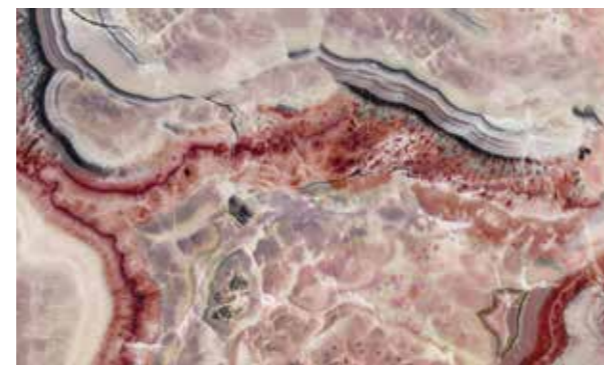

preziosi plum

Name	polished		polished	
	Code	Size(CM)	Code	Size(CM)
preziosi rio	A62GPRZS-RIO.NoX6P	120x260	A22GPRZS-RIO.NoX5P	120x120
preziosi pearl	A62GPRZS-PRL.NoX6P	120x260	A22GPRZS-PRL.NoX5P	120x120
preziosi green	A62GPRZS-GRE.NoX6P	120x260	A22GPRZS-GRE.NoX5P	120x120
preziosi rock	A62GPRZS-RCK.NoX6P	120x260	A22GPRZS-RCK.NoX5P	120x120
preziosi ocean	A62GPRZS-OCN.NoX6P	120x260	A22GPRZS-OCN.NoX5P	120x120
preziosi plum	A62GPRZS-PLM.NoX6P	120x260	-	-

Rain Marble

PORCELAIN TILES

Polished • Rectified • Smooth



SIZES

135x305 cm
>| < 14.5 mm

Available as a countertop – see page 182.

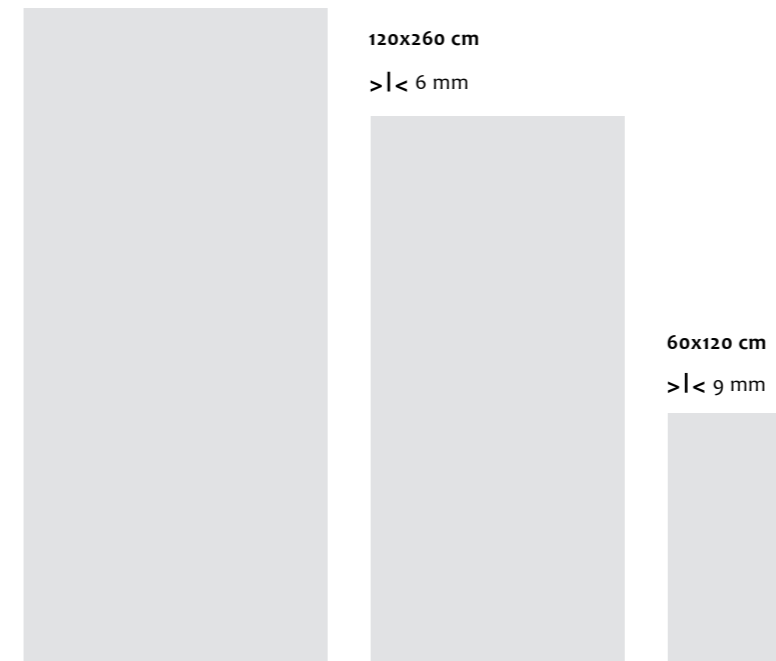

rain marble white



open book effect (face A)

open book effect (face B)

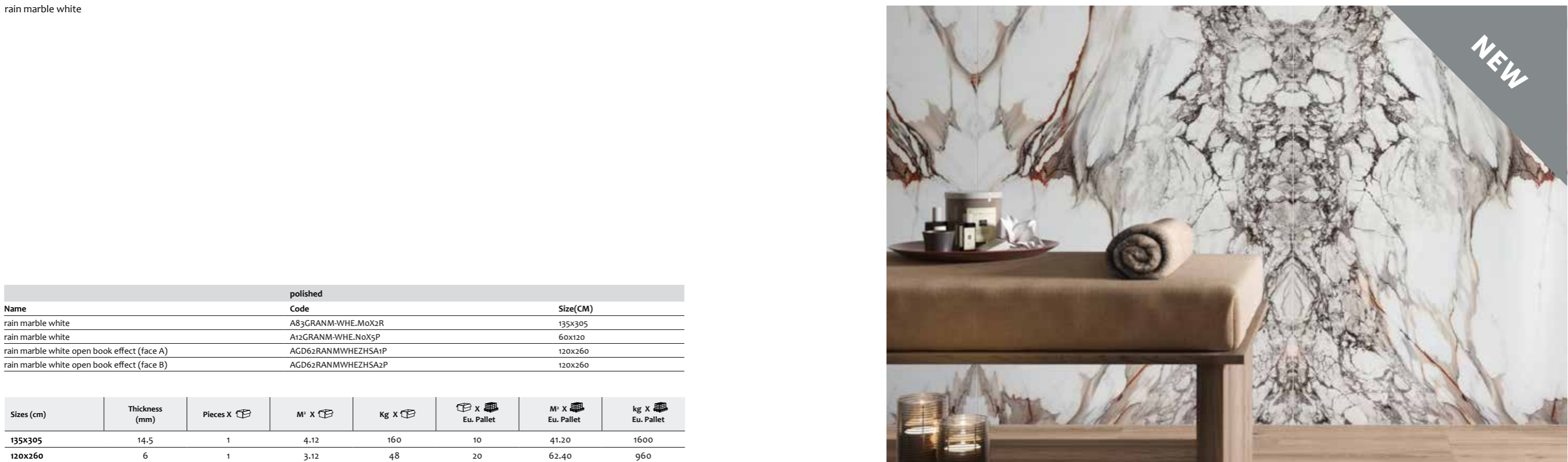

polished		
Name	Code	Size(CM)
rain marble white	A83GRANM-WHE.M0X2R	135x305
rain marble white	A12GRANM-WHE.NoX5P	60x120
rain marble white open book effect (face A)	AGD62RANMWHEZHS1P	120x260
rain marble white open book effect (face B)	AGD62RANMWHEZHS2P	120x260

Sizes (cm)	Thickness (mm)	Pieces X	M² X	Kg X	X Eu. Pallet	M² X Eu. Pallet	kg X Eu. Pallet
135x305	14.5	1	4.12	160	10	41.20	1600
120x260	6	1	3.12	48	20	62.40	960
60x120	9	1	1.44	33	30	43.20	900

Tech-Marble

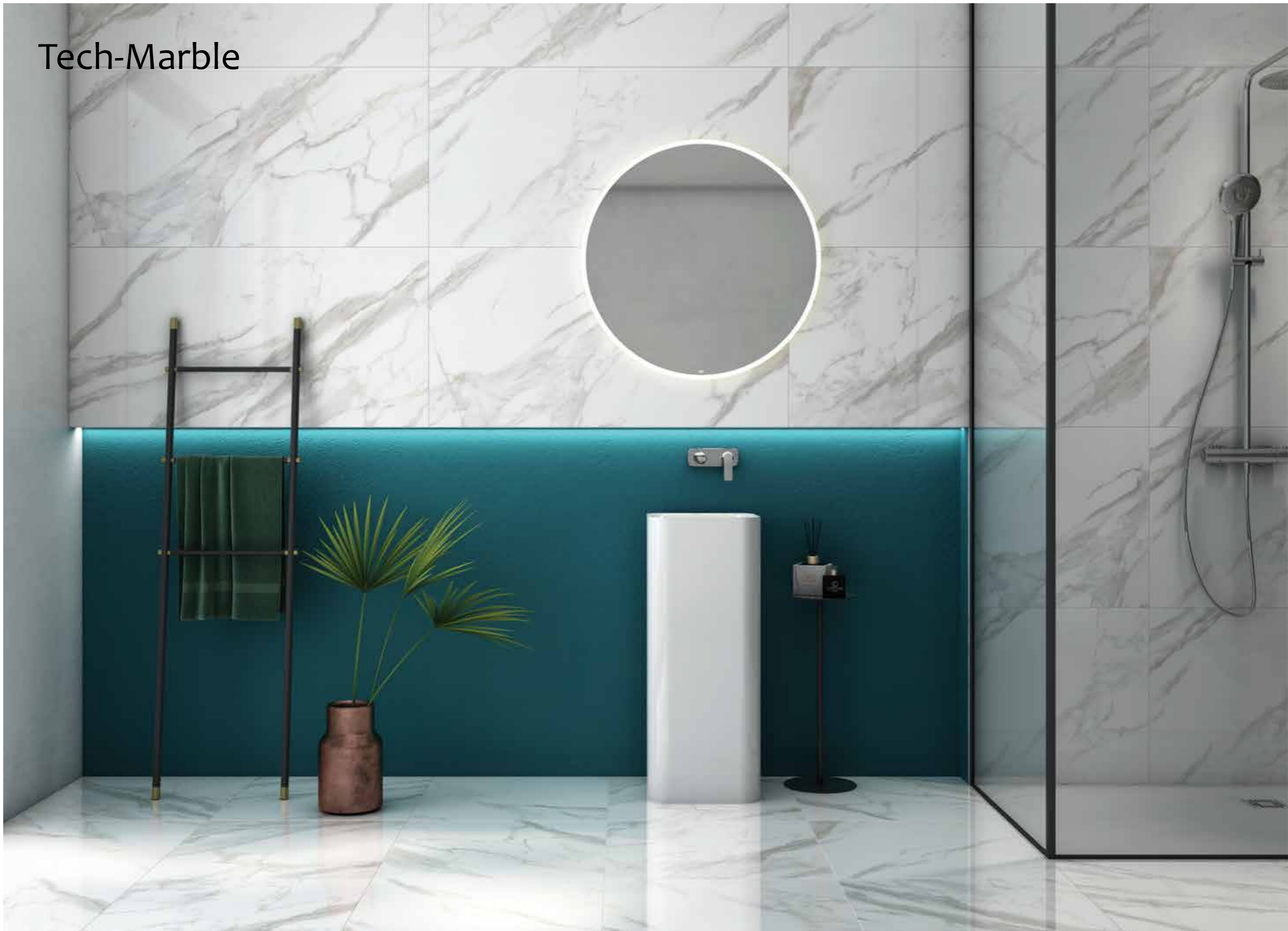

Tech-Marble

FULL BODY PORCELAIN TILES
Honed / Polished • Rectified • Smooth



tech-marble silver travertino

tech-marble calacatta africa

tech-marble grey silk

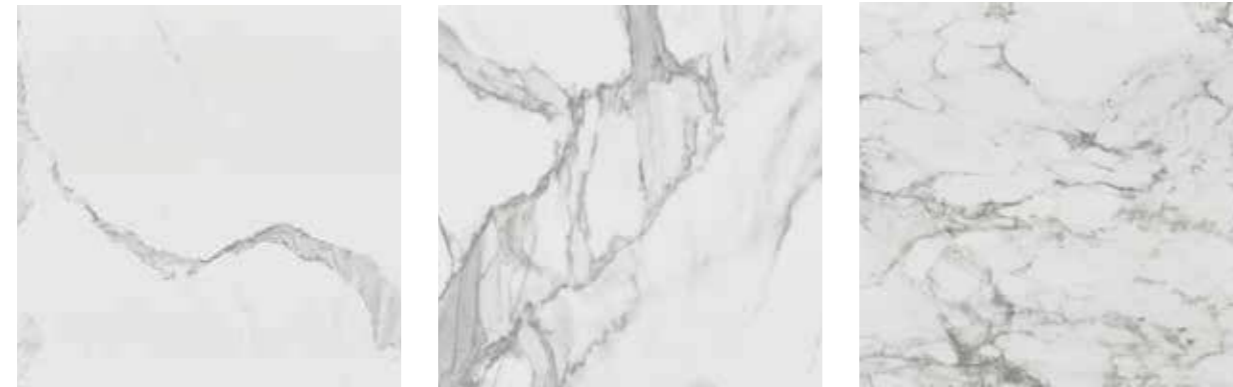

tech-marble white venato

tech-marble white statuario

tech-marble supreme white

FINISHES



honed



polished

Sizes (cm)	Thickness (mm)	Pieces X	M ² X	Kg X	X Eu. Pallet	M ² X Eu. Pallet	kg X Eu. Pallet
60x120	9	2	1.44	29	30	43.20	891
60x60	9	4	1.44	28	30	43.20	861



SIZES

60x120 cm

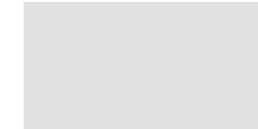

60x60 cm

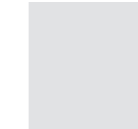

honed			polished		
Name	Code	Size(CM)	Code	Size(CM)	
tech-marble silver travertino	A12GTCMB-SRT.0oX5P	60x120	A12GTCMB-SRT.XoX5P	60x120	
tech-marble calacatta africa	A12GTCMB-CCA.0oX5P	60x120	A12GTCMB-CCA.XoX5P	60x120	
tech-marble grey silk	A12GTCMB-GSK.0oX5P	60x120	A12GTCMB-GSK.XoX5P	60x120	
tech-marble white venato	A12GTCMB-WVT.0oX5P	60x120	A12GTCMB-WVT.XoX5P	60x120	
tech-marble white statuario	A12GTCMB-WST.0oX5P	60x120	A12GTCMB-WST.XoX5P	60x120	
tech-marble supreme white	A12GTCMB-SUW.0oX5P	60x120	A12GTCMB-SUW.XoX5P	60x120	

honed			polished		
Name	Code	Size(CM)	Code	Size(CM)	
tech-marble silver travertino	Ao6GTCMB-SRT.0oXoP	60x60	Ao6GTCMB-SRT.XoXoP	60x60	
tech-marble calacatta africa	Ao6GTCMB-CCA.0oXoP	60x60	Ao6GTCMB-CCA.XoXoP	60x60	
tech-marble grey silk	Ao6GTCMB-GSK.0oXoP	60x60	Ao6GTCMB-GSK.XoXoP	60x60	
tech-marble white venato	Ao6GTCMB-WVT.0oXoP	60x60	Ao6GTCMB-WVT.XoXoP	60x60	
tech-marble white statuario	Ao6GTCMB-WST.0oXoP	60x60	Ao6GTCMB-WST.XoXoP	60x60	
tech-marble supreme white	Ao6GTCMB-SUW.0oXoP	60x60	Ao6GTCMB-SUW.XoXoP	60x60	

Urban Marble



PORCELAIN TILES

Polished • Rectified • Smooth



SIZES

60x120 cm

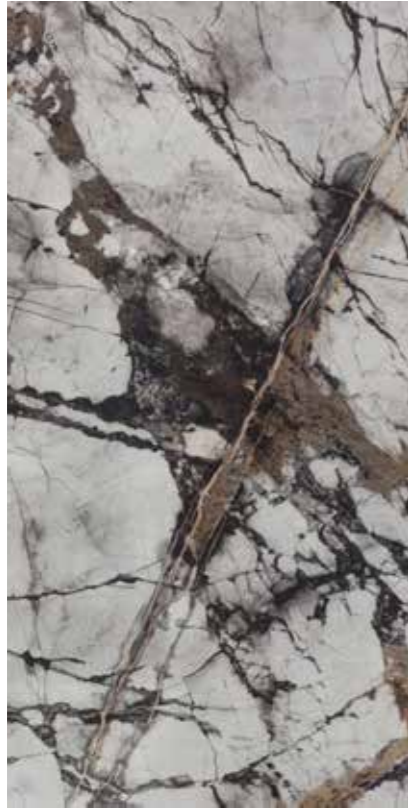
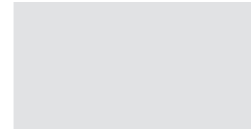

urban marble gold

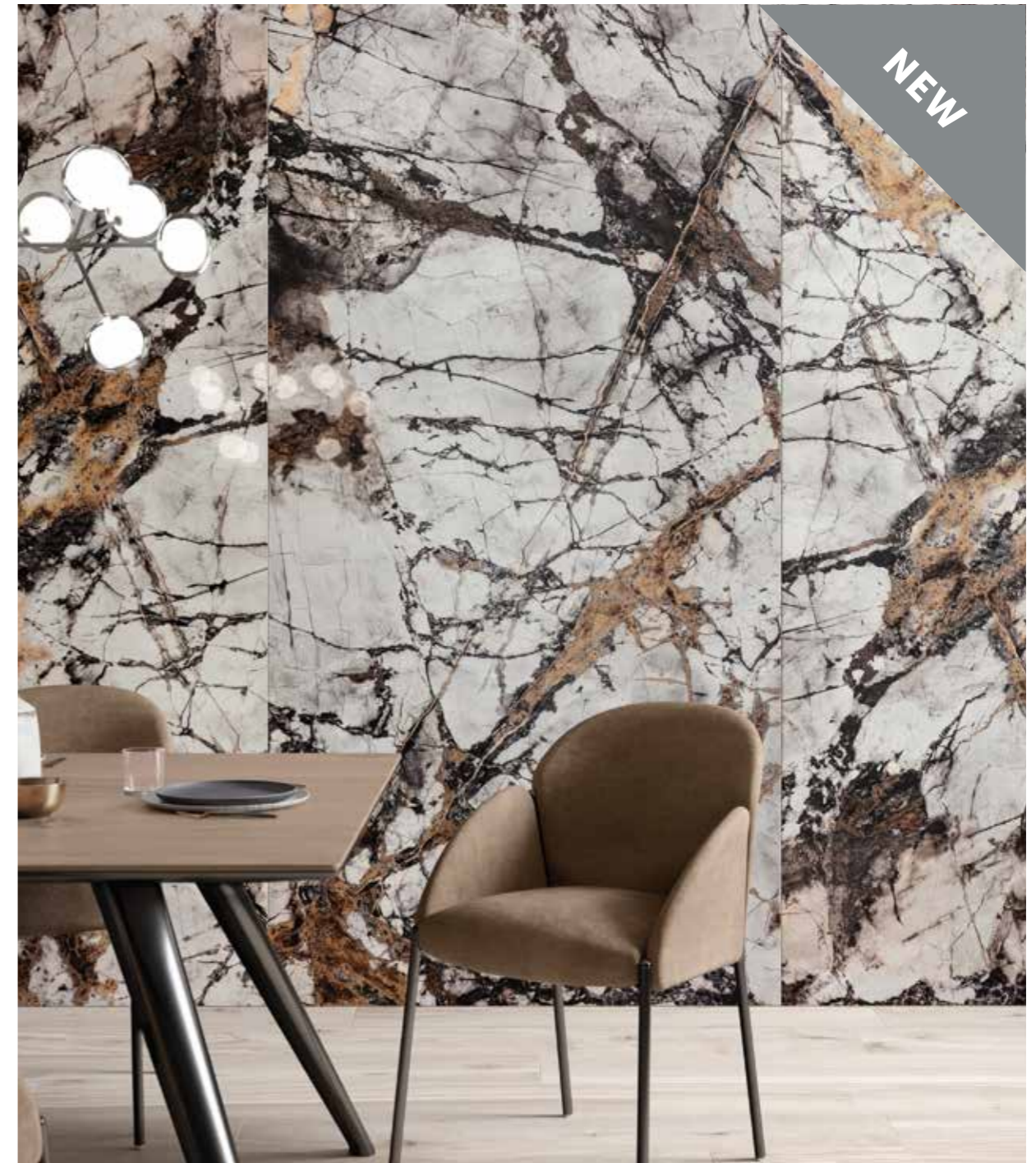

polished		
Name	Code	Size(CM)
urban marble gold	AGB12URBMOLEZHSS5P	60x120

Sizes (cm)	Thickness (mm)	Pieces X	M ² X	Kg X	X Eu. Pallet	M ² X Eu. Pallet	kg X Eu. Pallet
60x120	9	2	1.44	29	30	43.20	891

Venato Marble

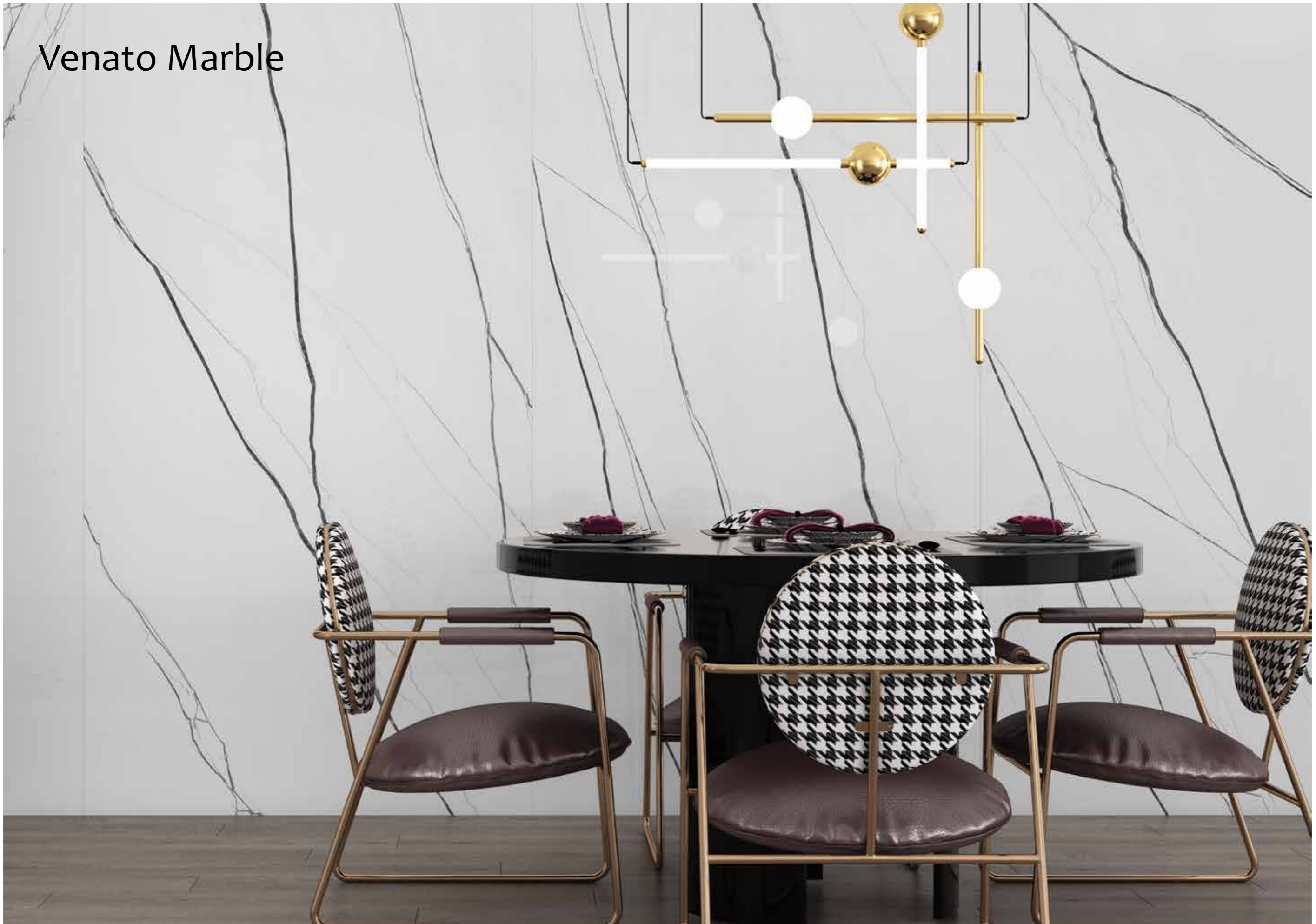

Venato Marble



PORCELAIN TILES

Polished • Rectified • Smooth

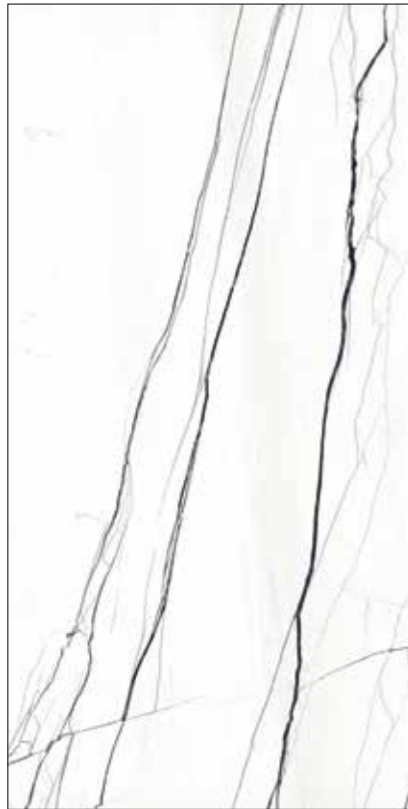

venato marble white

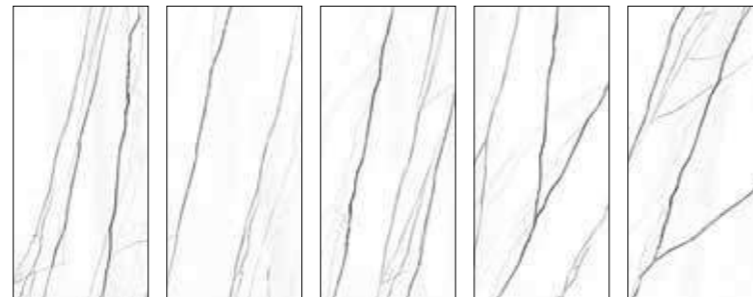

venato marble white variations
120x240 and 60x120

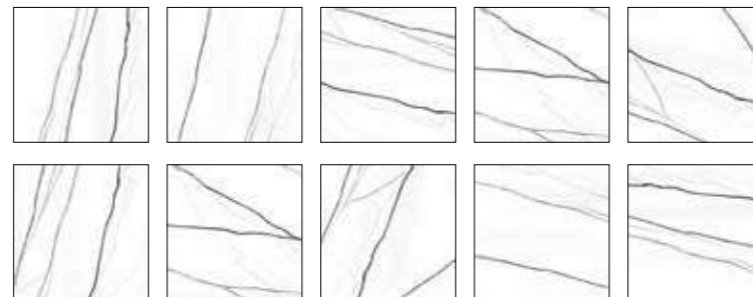

venato marble white variations
120x120

polished		
Name	Code	Size(CM)
venato marble white	A46GVEMB-WHE.HoX5P	120x240
venato marble white	A22GVEMB-WHE.HoX5P	120x120
venato marble white	A12GVEMB-WHE.HoX5P	60x120

Sizes (cm)	Thickness (mm)	Pieces X	M² X	Kg X	X Eu. Pallet	M² X Eu. Pallet	kg X Eu. Pallet
120x240	9	1	2.88	60	15	43.20	995
120x120	9	2	2.88	60	22	63.36	1320
60x120	9	2	1.44	29	30	43.20	891

SIZES

120x240 cm

>|< 9 mm

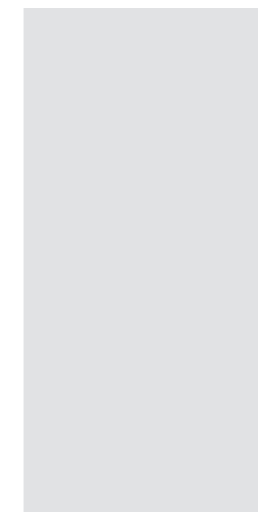

120x120 cm
>|< 9 mm

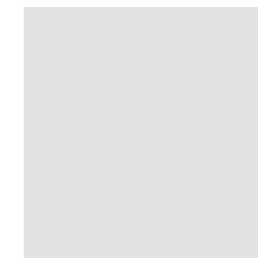

60x120 cm
>|< 9 mm



Versilia Marble



Versilia Marble

PORCELAIN TILES

Polished / Matt • Rectified • Smooth



SIZES

135x305 cm*
>|< 14.5 mm

*Available in polished only.
Available as a countertop
- see page 182.

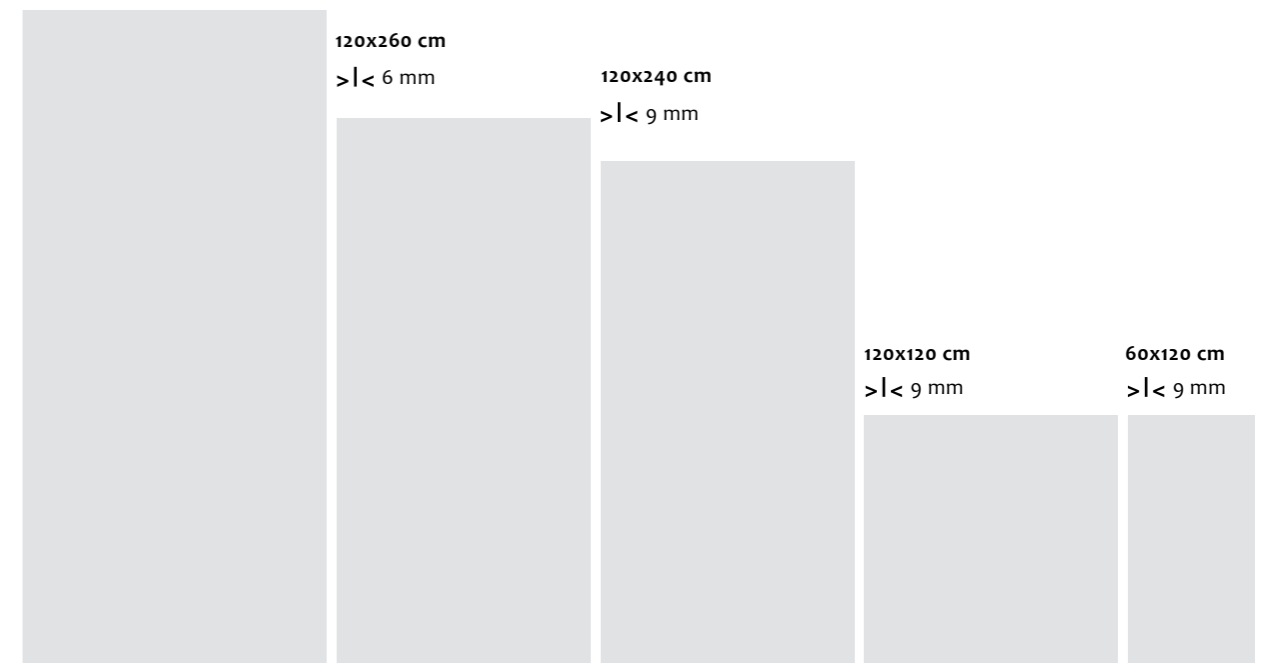

versilia marble white



versilia marble white variations
135x305, 120x260, 120x240 and 60x120



versilia marble white variations
120x120

FINISHES



polished



matt

Name	polished		matt	
	Code	Size(CM)	Code	Size(CM)
versilia marble white	AGB83VSMBWHEZHSLP	135x305	-	-
versilia marble white	AGB62VSMBWHEZHSC6P	120x260	A62GVSMB-WHE.MoX6R	120x260
versilia marble white	AGB46VSMBWHEZHSC3P	120x240	A46GVSMB-WHE.MoX5R	120x240
versilia marble white	AGB22VSMBWHEZHSC3P	120x120	A22GVSMB-WHE.MoX5R	120x120
versilia marble white	AGB12VSMBWHEZHSS5P	60x120	A12GVSMB-WHE.OoX5P	60x120

Sizes (cm)	Thickness (mm)	Pieces X	M² X	Kg X	X Eu. Pallet	M² X Eu. Pallet	Kg X Eu. Pallet
135x305	14.5	1	4.12	160	10	41.20	1600
120x260	6	1	3.12	48	20	62.40	960
120x240	9	1	2.88	60	15	43.20	995
120x120	9	2	2.88	60	22	63.36	1320
60x120	9	2	1.44	29	30	43.20	891



Metal

All the variations of a fascinating material

RAK Ceramics celebrates the dramatic effects and contrasting colours created during the ageing process of raw metal. With a bold and arresting appearance, the Metal collection for wall and floor, is perfect for urban and industrial settings. Metal-effect tiles are offered in a wide range of plain and decor: roughly ground steel, aged bronze, rusty metal sheet, etc. The range perfectly matches with any interior and decorative style, giving life to spaces that are both elegant and surprising.

Detroit Metal

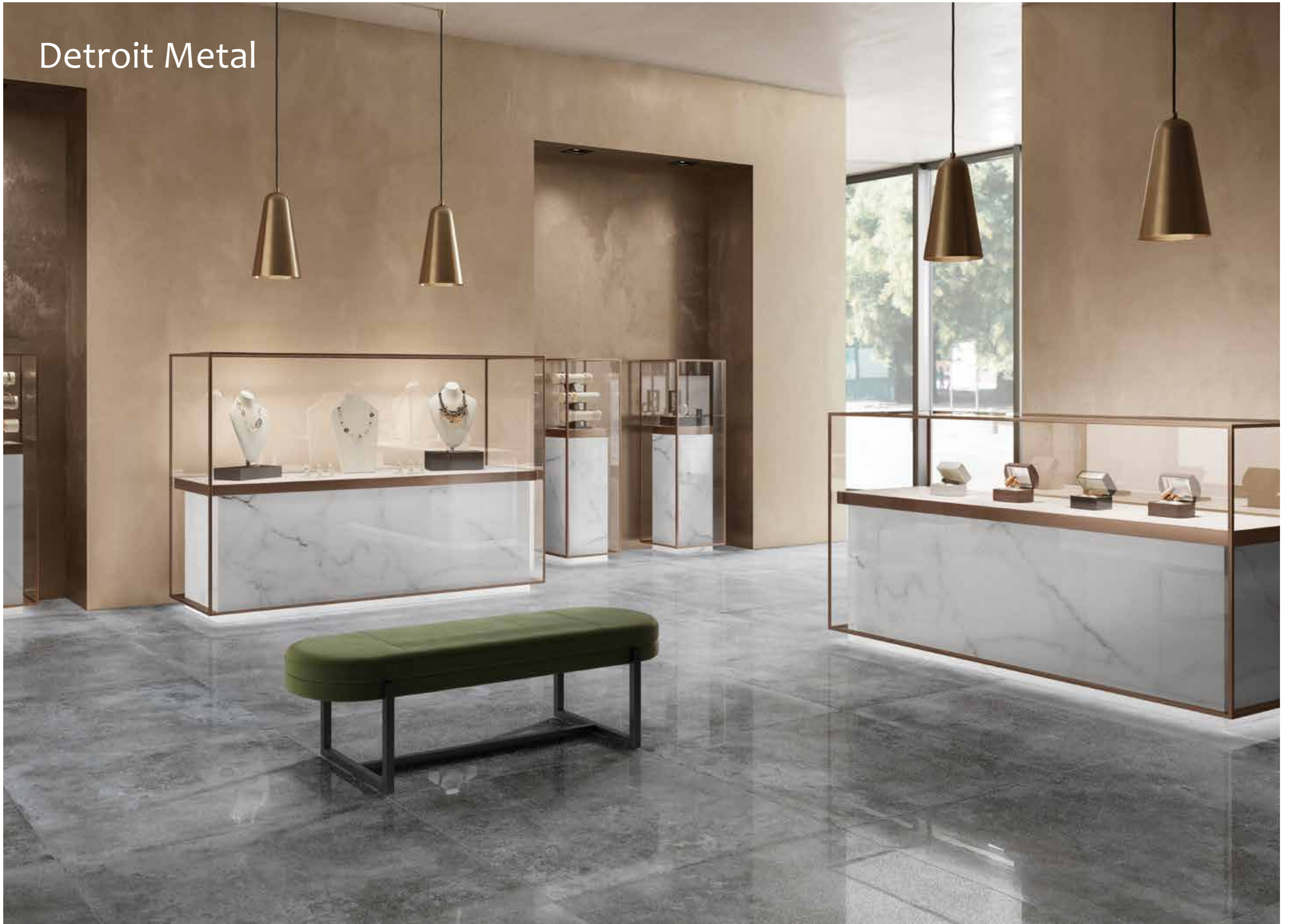

METAL

Detroit Metal

PORCELAIN TILES

Lappato • Rectified • Smooth



detroit metal beige



detroit metal brown



detroit metal taupe



detroit metal light grey



detroit metal grey

lappato			lappato		
Name	Code	Size(CM)	Code	Code	Size(CM)
detroit metal beige	AGB12DRMTBEEZMSS5L	60x120	AGB06DRMTBEEZMSNLL		60x60
detroit metal brown	AGB12DRMTBRNZMSS5L	60x120	AGB06DRMTBRNZMSNLL		60x60
detroit metal taupe	AGB12DRMTTPEZMSS5L	60x120	AGB06DRMTTPEZMSNLL		60x60
detroit metal light grey	AGB12DRMTLIGZMSS5L	60x120	AGB06DRMTLIGZMSNLL		60x60
detroit metal grey	AGB12DRMTGRYZMSS5L	60x120	AGB06DRMTGRYZMSNLL		60x60

lappato		
Name	Code	Size(CM)
detroit metal beige	A4QGDRMT#BEE.MoXoL	29.8x60
detroit metal brown	A4QGDRMT#BRN.MoXoL	29.8x60
detroit metal taupe	A4QGDRMT#TPE.MoXoL	29.8x60
detroit metal light grey	A4QGDRMT#LIG.MoXoL	29.8x60
detroit metal grey	A4QGDRMT#GRY.MoXoL	29.8x60



SIZES

60x120 cm

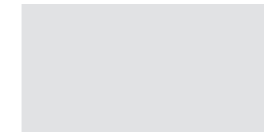

60x60 cm



29.8x60 cm

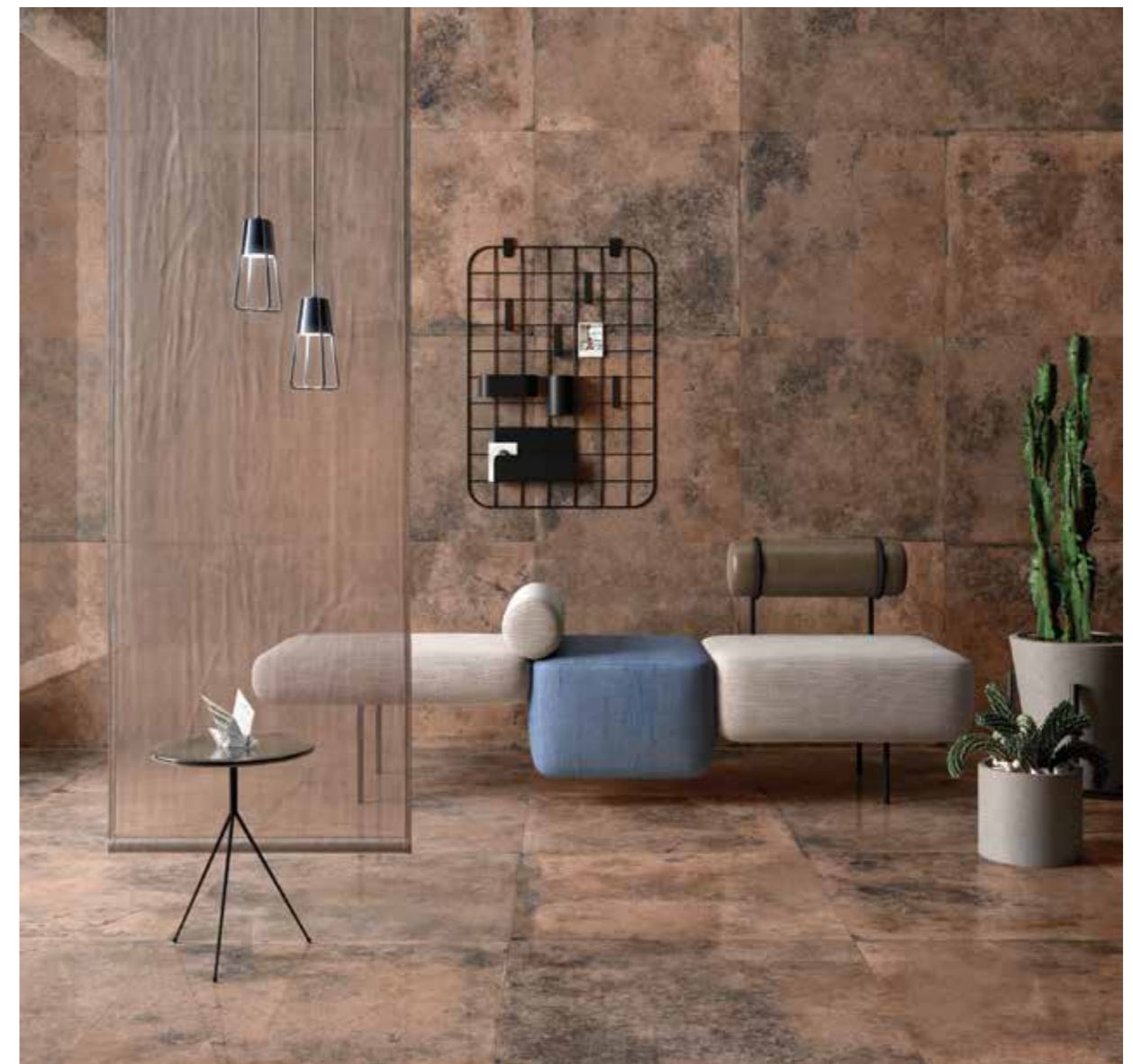

Sizes (cm)	Thickness (mm)	Pieces X	M² X	Kg X	X Eu. Pallet	M² X Eu. Pallet	kg X Eu. Pallet
60x120	9	2	1.44	29	30	43.20	891
60x60	9	4	1.44	28	30	43.20	861
29.8x60	9	6	1.08	23	40	43.20	941

Evoque Metal

SIGNATURE
COLLECTION

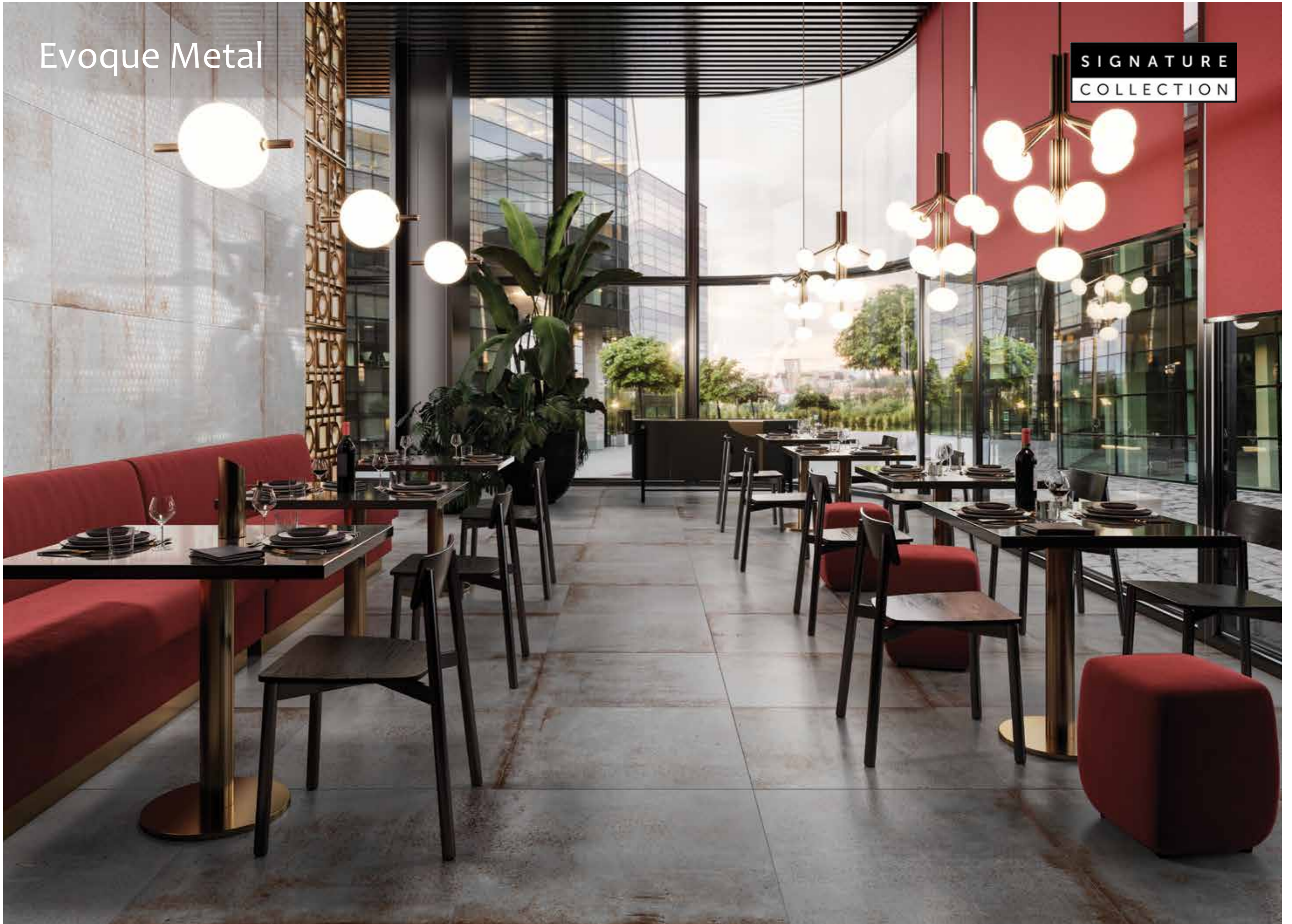

METAL

Evoque Metal

PORCELAIN TILES

Lappato / Matt • Rectified • Light Structure



evoque metal ice evoque metal grey evoque metal green grey evoque metal brown



evoque metal ice decor evoque metal grey decor evoque metal green grey decor evoque metal brown decor

FINISHES



lappato* matt

*Decor only available in lappato finish.

Sizes (cm)	Thickness (mm)	Pieces X	M² X	Kg X	X Eu. Pallet	M² X Eu. Pallet	kg X Eu. Pallet
60x120	9	2	1.44	29	30	43.20	891
60x60	9	4	1.44	28	30	43.20	861



SIZES

60x120 cm

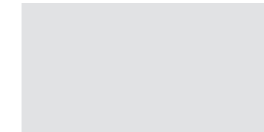

60x60 cm



lappato			matt	
Name	Code	Size(CM)	Code	Size(CM)
evoque metal ice	AGB12EVQMICEZMSS5L	60x120	AGB12EVQMICEZMSS5R	60x120
evoque metal grey	AGB12EVQMGRYZMSS5L	60x120	AGB12EVQMGRYZMSS5R	60x120
evoque metal green grey	AGB12EVQMGNZMSS5L	60x120	AGB12EVQMGNZMSS5R	60x120
evoque metal brown	AGB12EVQMBRNZMSS5L	60x120	AGB12EVQMBRNZMSS5R	60x120

lappato			matt	
Name	Code	Size(CM)	Code	Size(CM)
evoque metal ice	AGB06EVQMICEZMSNLL	60x60	AGB06EVQMICEZMSNLR	60x60
evoque metal grey	AGB06EVQMGRYZMSNLL	60x60	AGB06EVQMGRYZMSNLR	60x60
evoque metal green grey	AGB06EVQMGNZMSNLL	60x60	AGB06EVQMGNZMSNLR	60x60
evoque metal brown	AGB06EVQMBRNZMSNLL	60x60	AGB06EVQMBRNZMSNLR	60x60

lappato			lappato	
Name	Code	Size(CM)	Code	Size(CM)
evoque metal ice decor	AGD12EVQMICEZMSSSL	60x120	AGD06EVQMICEZMSSSL	60x60
evoque metal grey decor	AGD12EVQMGRYZMSSSL	60x120	AGD06EVQMGRYZMSSSL	60x60
evoque metal green grey decor	AGD12EVQMGNZMSSSL	60x120	AGD06EVQMGNZMSSSL	60x60
evoque metal brown decor	AGD12EVQMBRNZMSSSL	60x120	AGD06EVQMBRNZMSSSL	60x60



Wood

Be inspired by wood effect tiles

Natural-looking tiles are one of the key trends for indoor and outdoor floors, and wood is one of the most popular choices thanks to its versatility and beauty. Combining the aesthetic quality of natural timber with the durability of porcelain tiles, wood effect tiles are the perfect option when replacing a floor in a renovation project or laying a new floor in a newly-built property, as it helps in creating your own personal style. Parquet floor tiles can give any room the elegant look of hardwood, in an eco-friendly and new way. It's waterproof, highly resistant to scratches and chemicals, easy to clean, and resistant to heat and frost. It definitely looks like a good idea!

Circle Wood

SIGNATURE
COLLECTION



WOOD

Circle Wood

PORCELAIN TILES

Matt • Rectified • Light Structure



circle wood ivory



circle wood grey



circle wood nut



circle wood beige



circle wood brown

matt		
Name	Code	Size(CM)
circle wood ivory	A99GZCRW#IVo.W2S5R	19.5x120
circle wood grey	A99GZCRW#GYo.W2S5R	19.5x120
circle wood nut	A99GZCRW#NUo.W2S5R	19.5x120
circle wood beige	A99GZCRW#BEo.W2S5R	19.5x120
circle wood brown	A99GZCRW#BRo.W2S5R	19.5x120

SIZES



19.5x120 cm



Sizes (cm)	Thickness (mm)	Pieces X	M ² X	Kg X	X Eu. Pallet	M ² X Eu. Pallet	Kg X Eu. Pallet
19.5x120	9	5	1.17	25	36	42.12	921

Line Wood

SIGNATURE
COLLECTION

SUGAR
CLUB

WOOD

Line Wood

PORCELAIN TILES

Matt • Rectified • Light Structure



line wood ivory



line wood beige



line wood dark beige

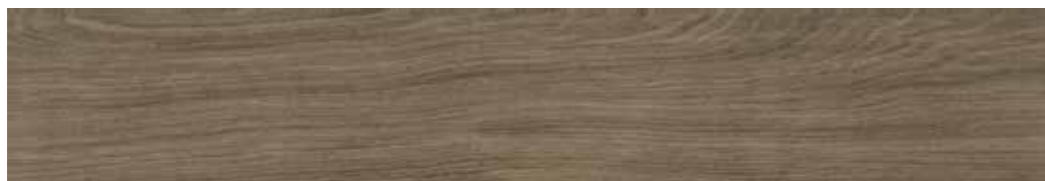

line wood brown



line wood dark brown

matt		
Name	Code	Size(CM)
line wood ivory	A99GZLNW#IVo.W2S5R	19,5x120
line wood beige	A99GZLNW#BEo.W2S5R	19,5x120
line wood dark beige	A99GZLNW#DBE.W2S5R	19,5x120
line wood brown	A99GZLNW#BRo.W2S5R	19,5x120
line wood dark brown	A99GZLNW#DBR.W2S5R	19,5x120

SIZES



19,5x120 cm

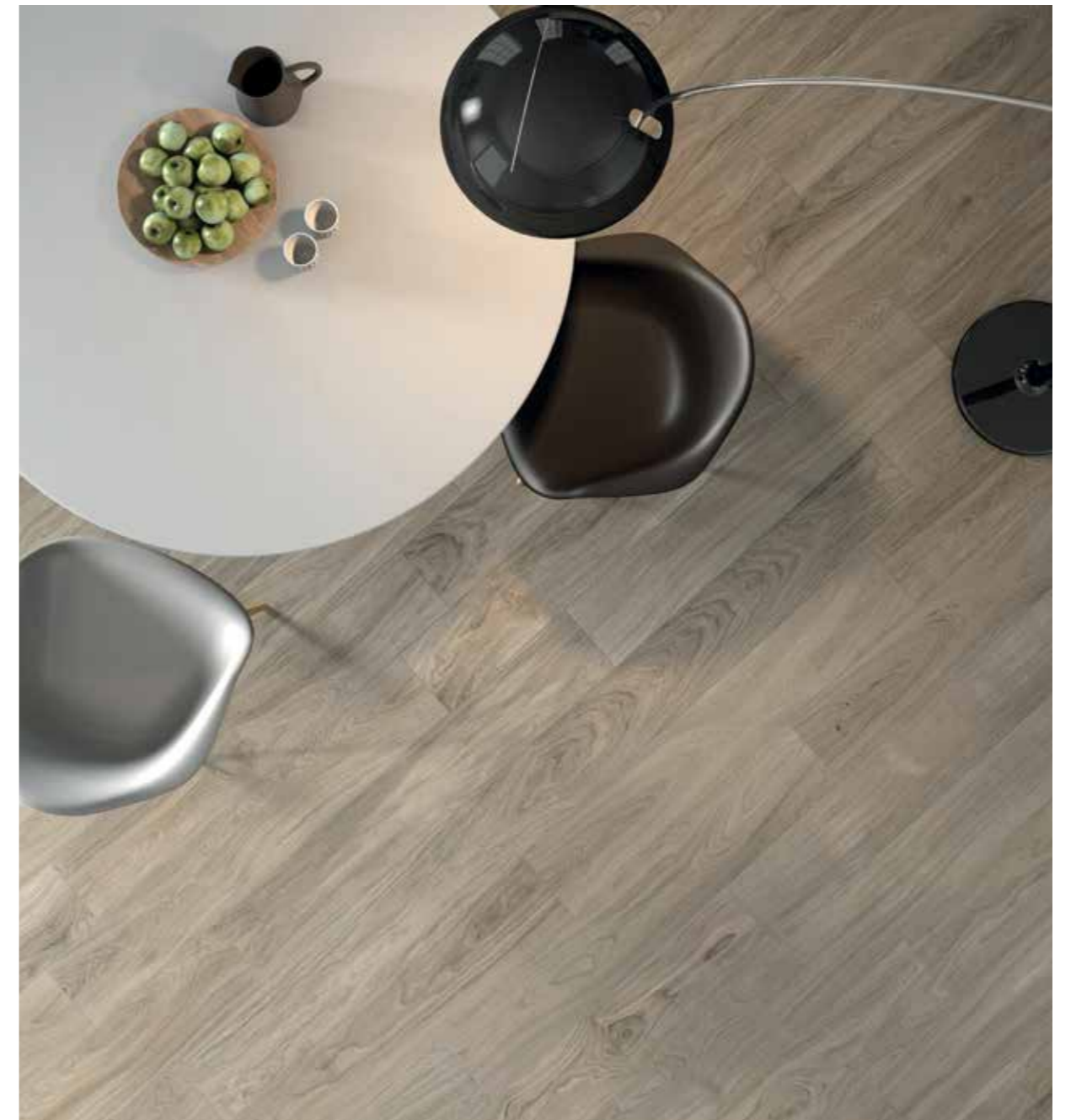
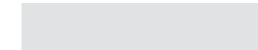

Sizes (cm)	Thickness (mm)	Pieces X	M ² X	Kg X	X Eu. Pallet	M ² X Eu. Pallet	kg X Eu. Pallet
19,5x120	9	5	1,17	25	36	42,12	921



Stone

No better way to create a relaxing environment

RAK Ceramics reinterprets the ancestral charm of stone and transforms it into one of the most preferred materials in contemporary architecture. Solid, durable and extremely versatile, the stone-look tiles have special features and a highly attractive visual impact. A traditional mood that is able to define interior design projects with a modern appeal. RAK Ceramics' stone collection is inspired by various types of stone existing in nature and is the ideal choice to create a particularly welcoming atmosphere that suits a sophisticated environment; providing a sensation of wellness and relaxation.

Carmo Stone

NEW



STONE

Carmo Stone

PORCELAIN TILES

Matt • Rectified • Light Structure



carmo stone grey



carmo stone anthracite



carmo stone ivory



carmo stone black

All colours are available in 12 faces

matt		
Name	Code	Size(CM)
carmo stone grey	A12GCMSO-GRY.M6X5R	60x120
carmo stone anthracite	A12GCMSO-ANT.M6X5R	60x120
carmo stone ivory	A12GCMSO-IVO.M6X5R	60x120
carmo stone black	A12GCMSO-BLK.M6X5R	60x120

Sizes (cm)	Thickness (mm)	Pieces X	M ² X	Kg X	X Eu. Pallet	M ² X Eu. Pallet	kg X Eu. Pallet
60x120	9	2	1.44	30	30	43.20	900

SIZES



60x120 cm

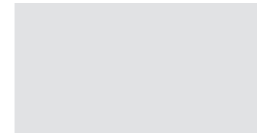

Available in a matching outdoor range – see page 222.

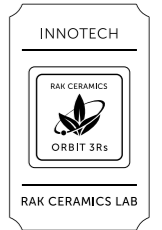

City Stone



STONE

City Stone

PORCELAIN TILES

Matt • Rectified • Light Structure



city stone bone



city stone grey



city stone anthracite



city stone clay

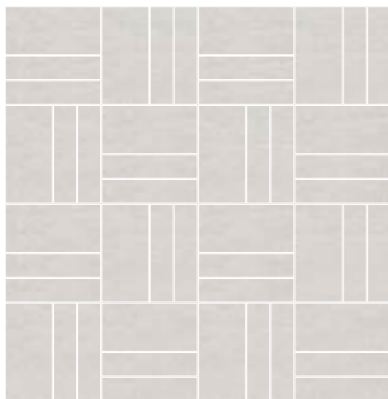

city stone bone mosaic 30x30cm



city stone bone mosaic 30x45cm

SIZES



60x120 cm

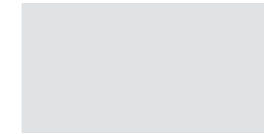

60x60 cm



30x60 cm

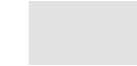

mosaic
30x30 cm



mosaic
30x45 cm



matt		matt		
Name	Code	Size(CM)	Code	Size(CM)
city stone bone	AGB12CTSEBNEZMLS5R	60x120	AGBo6CTSEBNEZMLNLR	60x60
city stone grey	AGB12CTSEGRYZMLS5R	60x120	AGBo6CTSEGRYZMLNLR	60x60
city stone anthracite	AGB12CTSEANTZMLS5R	60x120	AGBo6CTSEANTZMLNLR	60x60
city stone clay	AGB12CTSECLAZMLS5R	60x120	AGBo6CTSECLAZMLNLR	60x60

matt			
Name	Code	Size(CM)	
city stone bone	AGBo9CTSEBNEZMLNLR	30x60	-
city stone grey	AGBo9CTSEGRYZMLNLR	30x60	-
city stone anthracite	AGBo9CTSEANTZMLNLR	30x60	-
city stone clay	AGBo9CTSECLAZMLNLR	30x60	-

matt		matt		
Name	Code	Size(CM)	Code	Size(CM)
city stone bone mosaic	AGMZZCTSEBNE005615	30x30	AGMZZCTSEBNE005620	30x45
city stone grey mosaic	AGMZZCTSEGRY005617	30x30	AGMZZCTSEGRY005622	30x45
city stone anthracite mosaic	AGMZZCTSEANT005613	30x30	AGMZZCTSEANT005618	30x45
city stone clay mosaic	AGMZZCTSECLA005616	30x30	AGMZZCTSECLA005621	30x45

Sizes (cm)	Thickness (mm)	Pieces X	M² X	Kg X	X Eu. Pallet	M² X Eu. Pallet	kg X Eu. Pallet
60x120	9	2	1.44	29	30	43.20	891
60x60	9	4	1.44	28	30	43.20	861
30x60	9	6	1.08	23	40	43.20	941
mosaic 30x30	9	8	-	16	60	-	960
mosaic 30x45	9	6	-	13	30	-	411

Clay Stone

NEW



STONE

Clay Stone

PORCELAIN TILES

Matt • Rectified • Light Structure



clay stone beige



clay stone dark grey



clay stone grey



clay stone white

matt		
Name	Code	Size(CM)
clay stone beige	A09GCYSE-BEE.A6X0R	30x60
clay stone dark grey	A09GCYSE-DKG.A6X0R	30x60
clay stone grey	A09GCYSE-GRY.A6X0R	30x60
clay stone white	A09GCYSE-WHE.A6X0R	30x60
clay stone beige	A06GCYSE-BEE.A6X0R	60x60
clay stone dark grey	A06GCYSE-DKG.A6X0R	60x60
clay stone grey	A06GCYSE-GRY.A6X0R	60x60
clay stone white	A06GCYSE-WHE.A6X0R	60x60

Sizes (cm)	Thickness (mm)	Pieces X	M ² X	Kg X	X Eu. Pallet	M ² X Eu. Pallet	kg X Eu. Pallet
60x60	9	4	1.44	33	30	43.20	990
30x60	9	6	1.08	23	40	43.20	920

SIZES



60x60 cm



30x60 cm

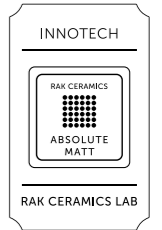
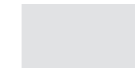

STONE

Curton



STONE

Curton

FULL BODY PORCELAIN TILES

Matt • Rectified • Smooth / Heavy Structure



curton white



curton white decor



curton grey

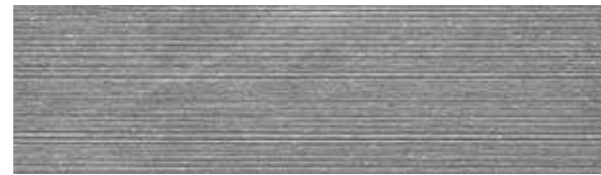

curton grey decor



curton taupe



curton taupe decor



curton beige



curton beige decor

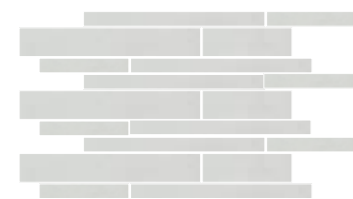

curton white mosaic 30x45cm

FINISHES



matt



matt decor



SIZES

60x120 cm

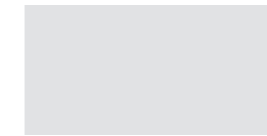

60x60 cm



29.8x60 cm

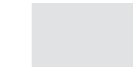

mosaic
30x45 cm

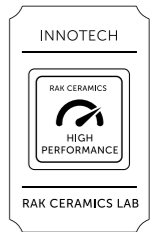

matt			matt		
Name	Code	Size(CM)	Code	Size(CM)	
curton white	A2B12PDCNWHEMSS5R	60x120	A2B06PDCNWHEMMSNLR	60x60	
curton grey	A2B12PDCNGRYMSS5R	60x120	A2B06PDCNGRYMMSNLR	60x60	
curton taupe	A2B12PDCNTPEMSS5R	60x120	A2B06PDCNTPEMMSNLR	60x60	
curton beige	A2B12PDCNBEEMSS5R	60x120	A2B06PDCNBEEMMSNLR	60x60	

matt			
Name	Code	Size(CM)	
curton white	A2X29PDCNWHEMMSNLR	29.8x60	
curton grey	A2X29PDCNGRYMMSNLR	29.8x60	
curton taupe	A2X29PDCNTPEMMSNLR	29.8x60	
curton beige	A2X29PDCNBEEMMSNLR	29.8x60	

matt			matt		
Name	Code	Size(CM)	Code	Size(CM)	
curton white decor	A2D12PDCNWHEMMLS5R	60x120	A2D06PDCNWHEMMLN1R	60x60	
curton grey decor	A2D12PDCNGRYMMLS5R	60x120	A2D06PDCNGRYMMLN1R	60x60	
curton taupe decor	A2D12PDCNTPEMMLS5R	60x120	A2D06PDCNTPEMMLN1R	60x60	
curton beige decor	A2D12PDCNBEEMMLS5R	60x120	A2D06PDCNBEEMMLN1R	60x60	

matt			
Name	Code	Size(CM)	
curton white decor	A29GPDNCN#WHE.MLXoR	29.8x60	
curton grey decor	A29GPDNCN#GRY.MLXoR	29.8x60	
curton taupe decor	A29GPDNCN#TPE.MLXoR	29.8x60	
curton beige decor	A29GPDNCN#BEE.MLXoR	29.8x60	

matt			
Name	Code	Size(CM)	
curton white mosaic	ACMZZPDCNWHE006690	30x45	
curton grey mosaic	ACMZZPDCNGRY005730	30x45	
curton taupe mosaic	ACMZZPDCNTP005731	30x45	
curton beige mosaic	ACMZZPDCNBE005729	30x45	

Sizes (cm)	Thickness (mm)	Pieces X	M² X	Kg X	X Eu. Pallet	M² X Eu. Pallet	kg X Eu. Pallet
60x120	9	2	1.44	29	30	43.20	891
60x60	9	4	1.44	28	30	43.20	861
29.8x60	9	6	1.08	23	40	43.20	941
mosaic 30x45	9	6	-	13	30	-	411

Fashion Stone



STONE

Fashion Stone

PORCELAIN TILES

Matt • Rectified • Light Structure



fashion stone light grey



fashion stone grey



fashion stone black



fashion stone ivory



fashion stone beige



fashion stone clay

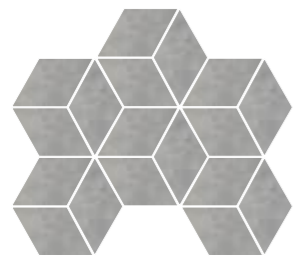

fashion stone light grey mosaic 25.5x29.5cm

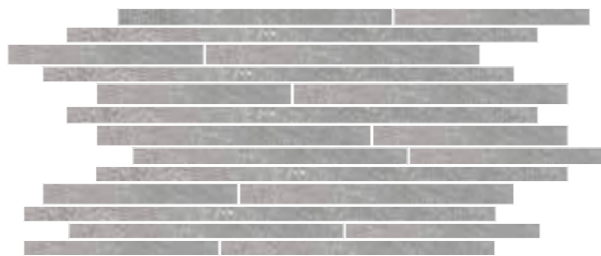

fashion stone light grey mosaic 30x60cm



SIZES

60x60 cm



30x60 cm

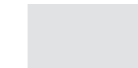

Available in a matching outdoor range
– see page 228.

mosaic
25.5x29.5 cm



mosaic
30x60 cm



matt			matt	
Name	Code	Size(CM)	Code	Size(CM)
fashion stone light grey	AGBo6FNSELIGZMLNLR	60x60	AGBo9FNSELIGZMLNLR	30x60
fashion stone grey	AGBo6FNSEGRYZMLNLR	60x60	AGBo9FNSEGRYZMLNLR	30x60
fashion stone black	AGBo6FNSEBLKZMLNLR	60x60	AGBo9FNSEBLKZMLNLR	30x60
fashion stone ivory	AGBo6FNSEIVZMLNLR	60x60	AGBo9FNSEIVZMLNLR	30x60
fashion stone beige	AGBo6FNSEBEEZMLNLR	60x60	AGBo9FNSEBEEZMLNLR	30x60
fashion stone clay	AGBo6FNSECLAZMLNLR	60x60	AGBo9FNSECLAZMLNLR	30x60

matt			matt	
Name	Code	Size(CM)	Code	Size(CM)
fashion stone light grey mosaic	AGWZZFNSELIG005500	25.5x29.5	AGMZZFNSELIG005644	30x60
fashion stone grey mosaic	AGWZZFNSEGRY005499	25.5x29.5	AGMZZFNSEGRY005643	30x60
fashion stone black mosaic	AGWZZFNSEBLK005497	25.5x29.5	AGMZZFNSEBLK005641	30x60
fashion stone ivory mosaic	AGWZZFNSEIVO006651	25.5x29.5	AGMZZFNSEIVO006640	30x60
fashion stone beige mosaic	AGWZZFNSEBEE006649	25.5x29.5	AGMZZFNSEBEE006632	30x60
fashion stone clay mosaic	AGWZZFNSECLA005498	25.5x29.5	AGMZZFNSECLA005642	30x60

Sizes (cm)	Thickness (mm)	Pieces X	M² X	Kg X	X Eu. Pallet	M² X Eu. Pallet	kg X Eu. Pallet
60x60	9	4	1.44	28	30	43.20	861
30x60	9	6	1.08	23	40	43.20	941
mosaic 25.5x29.5	9	10	-	23	36	-	828
mosaic 30x60	9	6	1.08	23	40	43.20	941

Lapideus



STONE

Lapideus

PORCELAIN TILES

Matt • Rectified • Light Structure



lapideus white



lapideus black



lapideus slate grey



lapideus dark grey



lapideus beige



lapideus original



lapideus pece



SIZES

60x120 cm

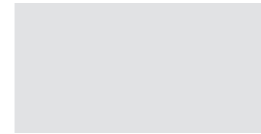

60x60 cm

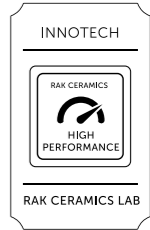

matt			matt		
Name	Code	Size(CM)	Code	Size(CM)	
lapideus white	A12GLPSE-WHE.M6X5R	60x120	Ao6GLPSE-WHE.M6XoR	60x60	
lapideus black	A12GLPSE-BLK.M6X5R	60x120	Ao6GLPSE-BLK.M6XoR	60x60	
lapideus slate grey	A12GLPSE-SLA.M6X5R	60x120	Ao6GLPSE-SLA.M6XoR	60x60	
lapideus dark grey	A12GLPSE-DKG.M6X5R	60x120	Ao6GLPSE-DKG.M6XoR	60x60	
lapideus beige	A12GLPSE-BEE.M6X5R	60x120	Ao6GLPSE-BEE.M6XoR	60x60	
lapideus original	A12GLPSE-OGL.M6X5R	60x120	Ao6GLPSE-OGL.M6XoR	60x60	
lapideus pece	A12GLPSE-PEC.M6X5R	60x120	Ao6GLPSE-PEC.M6XoR	60x60	

Sizes (cm)	Thickness (mm)	Pieces X	M² X	Kg X	X Eu. Pallet	M² X Eu. Pallet	kg X Eu. Pallet
60x120	9	2	1.44	29	30	43.20	891
60x60	9	4	1.44	28	30	43.20	861

Maremma

SIGNATURE
COLLECTION

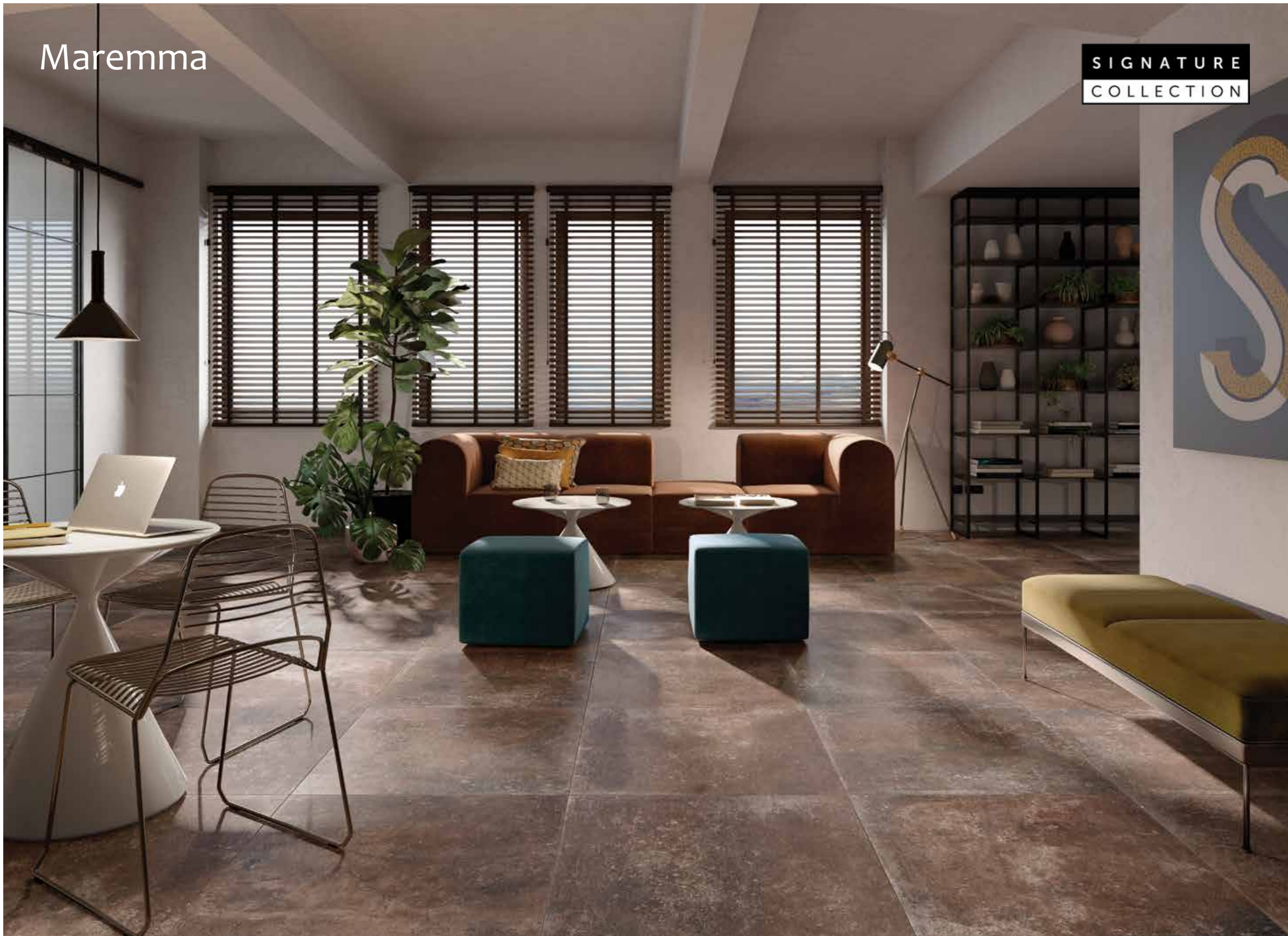

STONE

Maremma

PORCELAIN TILES

Matt • Rectified • Light Structure



maremma steel



maremma grey



maremma sand



maremma copper

matt			matt		
Name	Code	Size(CM)	Code	Size(CM)	
maremma steel	AGB12MRMASTEZMLS5R	60x120	AGB06MRMASTEZMLNLR	60x60	
maremma copper	AGB12MRMACOPZMLS5R	60x120	AGB06MRMACOPZMLNLR	60x60	
maremma grey	AGB12MRMAGRYZMLS5R	60x120	AGB06MRMAGRYZMLNLR	60x60	
maremma sand	AGB12MRMASNDZMLS5R	60x120	AGB06MRMASNDZMLNLR	60x60	

Sizes (cm)	Thickness (mm)	Pieces X	M² X	Kg X	X Eu. Pallet	M² X Eu. Pallet	kg X Eu. Pallet
60x120	9	2	1.44	29	30	43.20	891
60x60	9	4	1.44	28	30	43.20	861

SIZES



60x120 cm

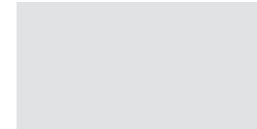

60x60 cm

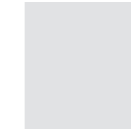

Available in a matching outdoor range
– see page 230.



Paleo

NEW



STONE

Paleo

PORCELAIN TILES

Matt • Rectified • Smooth



paleo beige



paleo anthracite



paleo clay



paleo grey



paleo warm grey



paleo white

matt		
Name	Code	Size(CM)
paleo beige	Ao5GPAEO-BEE.AoXoR	80x80
paleo anthracite	Ao5GPAEO-ANT.AoXoR	80x80
paleo clay	Ao5GPAEO-CLA.AoXoR	80x80
paleo grey	Ao5GPAEO-GRY.AoXoR	80x80
paleo warm grey	Ao5GPAEO-WGY.AoXoR	80x80
paleo white	Ao5GPAEO-WHE.AoXoR	80x80

Sizes (cm)	Thickness (mm)	Pieces X	M ² X	Kg X	X Eu. Pallet	M ² X Eu. Pallet	kg X Eu. Pallet
80x80	9	2	1.28	25.5	40	51.20	1020

SIZES



80x80 cm

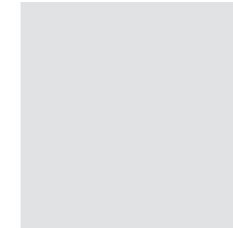

STONE

Rapolano

NEW



STONE

Rapolano

PORCELAIN TILES

Matt • Rectified • Smooth



rapolano beige



rapolano light beige



rapolano white



rapolano grey

matt		
Name	Code	Size(CM)
rapolano beige	Ao5GRLMB-BEE.MoXoR	80x80
rapolano light beige	Ao5GRLMB-LBE.MoXoR	80x80
rapolano white	Ao5GRLMB-WHE.MoXoR	80x80
rapolano grey	Ao5GRLMB-GRY.MoXoR	80x80

Sizes (cm)	Thickness (mm)	Pieces X	M ² X	Kg X	X Eu. Pallet	M ² X Eu. Pallet	kg X Eu. Pallet
80x80	9	2	1.28	25.5	40	51.20	1020

SIZES



80x80 cm
>|< 9 mm



STONE

Shine Stone

SIGNATURE
COLLECTION



STONE

Shine Stone

PORCELAIN TILES

Matt • Rectified • Light Structure



SIZES



matt			matt	
Name	Code	Size(CM)	Code	Size(CM)
shine stone white	Ao6GZSHS-WHo.M2R	60x60	Ao9GZSHS#WHo.M2R	30x60
shine stone grey	Ao6GZSHS-GYo.M2R	60x60	Ao9GZSHS#GYo.M2R	30x60
shine stone dark grey	Ao6GZSHS-DGY.M2R	60x60	Ao9GZSHS#DGY.M2R	30x60
shine stone ivory	Ao6GZSHS-IVo.M2R	60x60	Ao9GZSHS#IVo.M2R	30x60
shine stone beige	Ao6GZSHS-BEo.M2R	60x60	Ao9GZSHS#BEo.M2R	30x60

matt			matt	
Name	Code	Size(CM)	Code	Size(CM)
shine stone white	ACT-06ZSHS-WHo.2RC	15x60	ACT-06ZSHS-WHo.2RB	10x60
shine stone grey	ACT-06ZSHS-GYo.2RC	15x60	ACT-06ZSHS-GYo.2RB	10x60
shine stone dark grey	ACT-06ZSHS-DGY.2RC	15x60	ACT-06ZSHS-DGY.2RB	10x60
shine stone ivory	ACT-06ZSHS-IVo.2RC	15x60	ACT-06ZSHS-IVo.2RB	10x60
shine stone beige	ACT-06ZSHS-BEo.2RC	15x60	ACT-06ZSHS-BEo.2RB	10x60

matt		
Name	Code	Size(CM)
shine stone white	ACT-06ZSHS-WHo.2RA	5x60
shine stone grey	ACT-06ZSHS-GYo.2RA	5x60
shine stone dark grey	ACT-06ZSHS-DGY.2RA	5x60
shine stone ivory	ACT-06ZSHS-IVo.2RA	5x60
shine stone beige	ACT-06ZSHS-BEo.2RA	5x60



shine stone white



shine stone ivory



shine stone grey



shine stone beige



shine stone dark grey

Sizes (cm)	Thickness (mm)	Pieces X	M² X	Kg X	X Eu. Pallet	M² X Eu. Pallet	kg X Eu. Pallet
60x60	9	4	1.44	28	30	43.20	861
30x60	9	6	1.08	23	40	43.20	941
15x60	9	12	1.08	24	40	43.20	981
10x60	9	18	1.08	24	40	43.20	981
5x60	9	36	1.08	24	40	43.20	981



Concrete

The ultimate expression of minimalism

RAK Ceramics' concrete collection makes a powerful statement with its sheer simplicity. No fuss, no frills, just pure perfection. With its neutral colour and natural texture, the concrete-look tiles are the ideal choice in creating a minimalist look and feel. It is a versatile collection that is well suited in any setting, either with a contemporary or minimalist mood, and is ideal for both residential or industrial ambiances.

Basic Concrete



CONCRETE

Basic Concrete

PORCELAIN TILES

Matt • Rectified • Light Structure



basic concrete grey



basic concrete beige



basic concrete dark grey



basic concrete dark beige

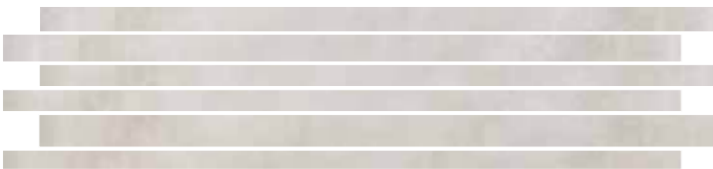

basic concrete grey multi strip mosaic 15x60cm

Sizes (cm)	Thickness (mm)	Pieces X	M² X	Kg X	X Eu. Pallet	M² X Eu. Pallet	kg X Eu. Pallet
60x60	9	4	1.44	28	30	43.20	861
30x60	9	6	1.08	23	40	43.20	941
15x60	9	12	1.08	24	40	43.20	981



SIZES

60x60 cm



30x60 cm

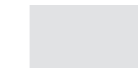

multi strip mosaic
15x60 cm



matt			matt		
Name	Code	Size(CM)	Code	Size(CM)	
basic concrete grey	Ao6GZBSC-GYo.M2R	60x60	Ao9GZBSC-GYo.M2R	30x60	
basic concrete dark grey	Ao6GZBSC-DGY.M2R	60x60	Ao9GZBSC#DGY.M2R	30x60	
basic concrete beige	Ao6GZBSC-BEo.M2R	60x60	Ao9GZBSC#BEo.M2R	30x60	
basic concrete dark beige	Ao6GZBSC-DBE.M2R	60x60	Ao9GZBSC#DBE.M2R	30x60	

matt		
Name	Code	Size(CM)
basic concrete grey multi strip mosaic	AMBGZBSC-GY.2R/BRK	15x60
basic concrete dark grey multi strip mosaic	AMBGZBSC-DG.2R/BRK	15x60
basic concrete beige multi strip mosaic	AMBGZBSC-BE.2R/BRK	15x60
basic concrete dark beige multi strip mosaic	AMBGZBSC-DB.2R/BRK	15x60

Loft Concrete

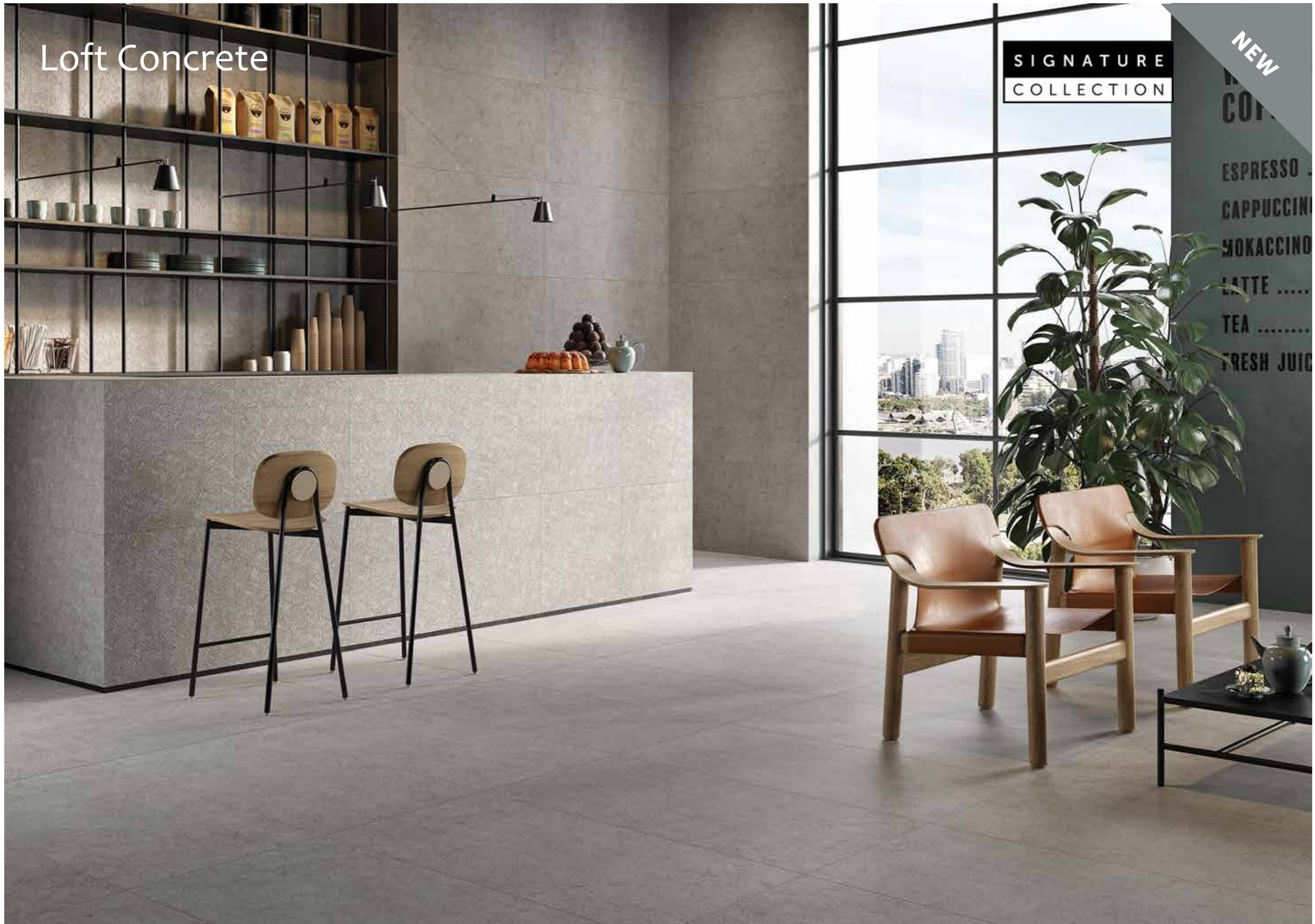

SIGNATURE
COLLECTION

NEW
COFFEE
ESPRESSO
CAPPUCCINO
MOKACCINO
LATTE
TEA
FRESH JUICE

CONCRETE

Loft Concrete

PORCELAIN TILES

Matt • Rectified • Smooth / Light Structure



loft concrete dark grey

loft concrete ivory

loft concrete light beige



loft concrete silver grey

loft concrete warm grey

matt			matt		
Name	Code	Size(CM)	Code	Size(CM)	
loft concrete dark grey	Ao6GLFTC-DKG.M6XoR	60x60	Ao9GLFTC#DKG.M6XoR	30x60	
loft concrete ivory	Ao6GLFTC-IVO.M6XoR	60x60	Ao9GLFTC#IVO.M6XoR	30x60	
loft concrete light beige	Ao6GLFTC-LBE.M6XoR	60x60	Ao9GLFTC#LBE.M6XoR	30x60	
loft concrete silver grey	Ao6GLFTC-SIR.M6XoR	60x60	Ao9GLFTC#SIR.M6XoR	30x60	
loft concrete warm grey	Ao6GLFTC-WGY.M6XoR	60x60	Ao9GLFTC#WGY.M6XoR	30x60	

Sizes (cm)	Thickness (mm)	Pieces X	M² X	Kg X	X Eu. Pallet	M² X Eu. Pallet	kg X Eu. Pallet
60x60	9	4	1.44	33	30	43.20	990
30x60	9	6	1.08	23	40	43.20	920

SIZES



60x60 cm

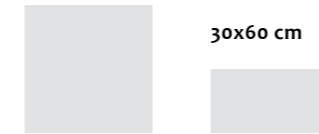

30x60 cm

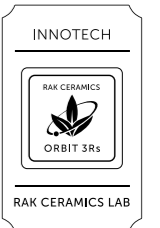

CONCRETE

Lounge



CONCRETE

Lounge

FULL BODY PORCELAIN TILES

Matt / Polished / Rustic • Rectified • Smooth / Heavy Structure



lounge ivory lounge light grey lounge grey lounge anthracite



lounge dark anthracite lounge black lounge beige lounge mocca

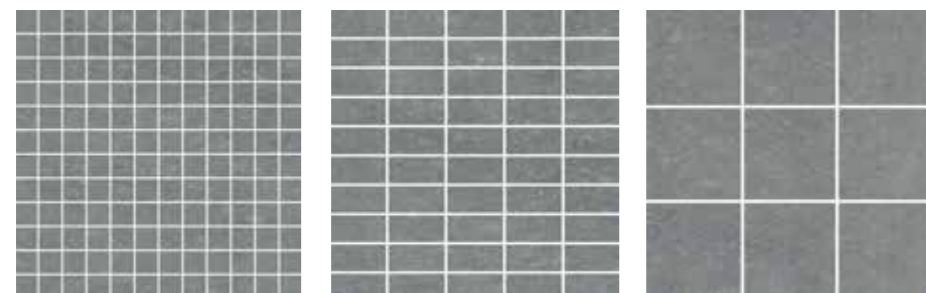

lounge anthracite mosaic 2.5x2.5, 30x30cm lounge anthracite mosaic 3x6, 30x30cm lounge anthracite mosaic 10x10, 30x30cm

FINISHES



matt rustic polished

SIZES

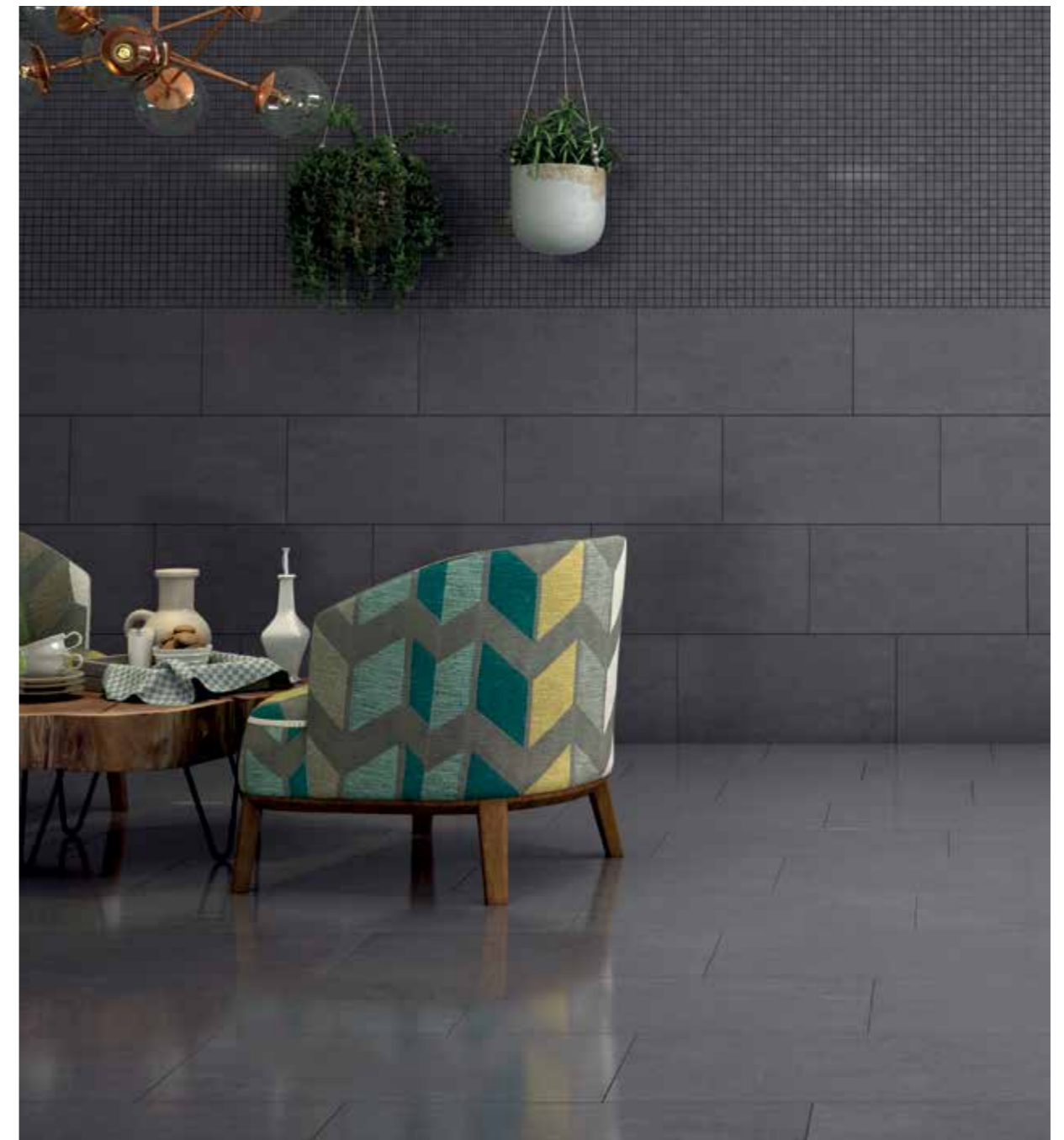
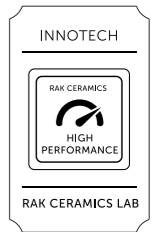
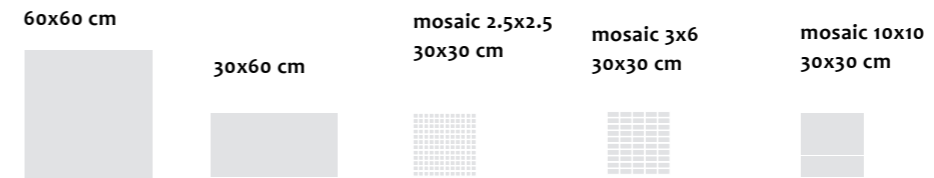

Lounge

matt			polished	
Name	Code	Size(CM)	Code	Size(CM)
lounge ivory	Ao6GLOUN-085.UoR	60x60	Ao6GLOUN-085.XoP	60x60
lounge light grey	Ao6GLOUN-052.UoR	60x60	Ao6GLOUN-052.XoP	60x60
lounge grey	Ao6GLOUN-059.UoR	60x60	Ao6GLOUN-059.XoP	60x60
lounge anthracite	Ao6GLOUN-056.UoR	60x60	Ao6GLOUN-054.XoP	60x60
lounge dark anthracite	Ao6GLOUN-055.UoR	60x60	Ao6GLOUN-055.XoP	60x60
lounge black	Ao6GLOUN-057.UoR	60x60	Ao6GLOUN-057.XoP	60x60
lounge beige	Ao6GLOUN-053.UoR	60x60	Ao6GLOUN-053.XoP	60x60
lounge mocca	Ao6GLOUN-662.UoR	60x60	Ao6GLOUN-662.XoP	60x60

matt			polished	
Name	Code	Size(CM)	Code	Size(CM)
lounge ivory	Ao9GLOUN-085.UoR	30x60	Ao9GLOUN-085.XoP	30x60
lounge light grey	Ao9GLOUN-052.UoR	30x60	Ao9GLOUN-052.XoP	30x60
lounge grey	Ao9GLOUN-059.UoR	30x60	Ao9GLOUN-059.XoP	30x60
lounge anthracite	Ao9GLOUN-056.UoR	30x60	Ao9GLOUN-054.XoP	30x60
lounge dark anthracite	Ao9GLOUN-055.UoR	30x60	Ao9GLOUN-055.XoP	30x60
lounge black	Ao9GLOUN-057.UoR	30x60	Ao9GLOUN-057.XoP	30x60
lounge beige	Ao9GLOUN-053.UoR	30x60	Ao9GLOUN-053.XoP	30x60
lounge mocca	Ao9GLOUN-662.UoR	30x60	Ao9GLOUN-662.XoP	30x60

rustic		
Name	Code	Size(CM)
lounge ivory	Ao9GLOUN-085.U2R	30x60
lounge light grey	Ao9GLOUN-052.U2R	30x60
lounge grey	Ao9GLOUN-059.U2R	30x60
lounge anthracite	Ao9GLOUN-056.U2R	30x60
lounge dark anthracite	Ao9GLOUN-055.U2R	30x60
lounge black	Ao9GLOUN-057.U2R	30x60
lounge beige	Ao9GLOUN-053.U2R	30x60
lounge mocca	Ao9GLOUN-662.U2R	30x60

matt			polished	
Name	Code	Size(CM)	Code	Size(CM)
lounge ivory mosaic 2.5x2.5	AM-GPD-85UPM/2H	30x30	-	-
lounge light grey mosaic 2.5x2.5	AM-GPD-52UP	30x30	AM-9GPD-52P	30x30
lounge grey mosaic 2.5x2.5	AM-9GPD-59UP	30x30	AM-GPD-59/2H	30x30
lounge anthracite mosaic 2.5x2.5	AM-GPD-56UP/A	30x30	AM-GPD-54/A	30x30
lounge dark anthracite mosaic 2.5x2.5	AM-GPD-55UP	30x30	-	-
lounge black mosaic 2.5x2.5	AM-7GPD-57UP	30x30	AM-GPD-57P	30x30
lounge beige mosaic 2.5x2.5	AM-7GPD-53UP	30x30	AM-30GLOUN-053/A	30x30
lounge mocca mosaic 2.5x2.5	AM-GPD-662UPM/2H	30x30	AM-30GPD-662P/2H	30x30
lounge mixed mosaic 2.5x2.5	AM-GPD-56/57/59UP	30x30	AM-GPD-56/57/59P	30x30

matt		
Name	Code	Size(CM)
lounge ivory mosaic 3x6	AM-GPD-85UPM3/6	30x30
lounge light grey mosaic 3x6	AM-GPD-52UP/A	30x30
lounge grey mosaic 3x6	AM-GPD-59UP3/6	30x30
lounge anthracite mosaic 3x6	AM-GPD-56UPA	30x30
lounge dark anthracite mosaic 3x6	AM-GPD-55,RT	30x30
lounge black mosaic 3x6	AM-GPD-57UP	30x30
lounge beige mosaic 3x6	AM-GPD-53UP	30x30
lounge mocca mosaic 3x6	AM-GPD-662UP	30x30

matt		
Name	Code	Size(CM)
lounge ivory mosaic 10x10	AM-GPD-85UP10/10	30x30
lounge light grey mosaic 10x10	AM-GPD-52UP10/10	30x30
lounge grey mosaic 10x10	AM-GPD-59UP10/10	30x30
lounge anthracite mosaic 10x10	AM-GPD-56UP10/10	30x30
lounge dark anthracite mosaic 10x10	AM-GPD-55UP10/10	30x30
lounge black mosaic 10x10	AM-GPD-57UP10/10	30x30
lounge beige mosaic 10x10	AM-GPD-53UP10/10	30x30
lounge mocca mosaic 10x10	AM-GPD-662UP10/10	30x30

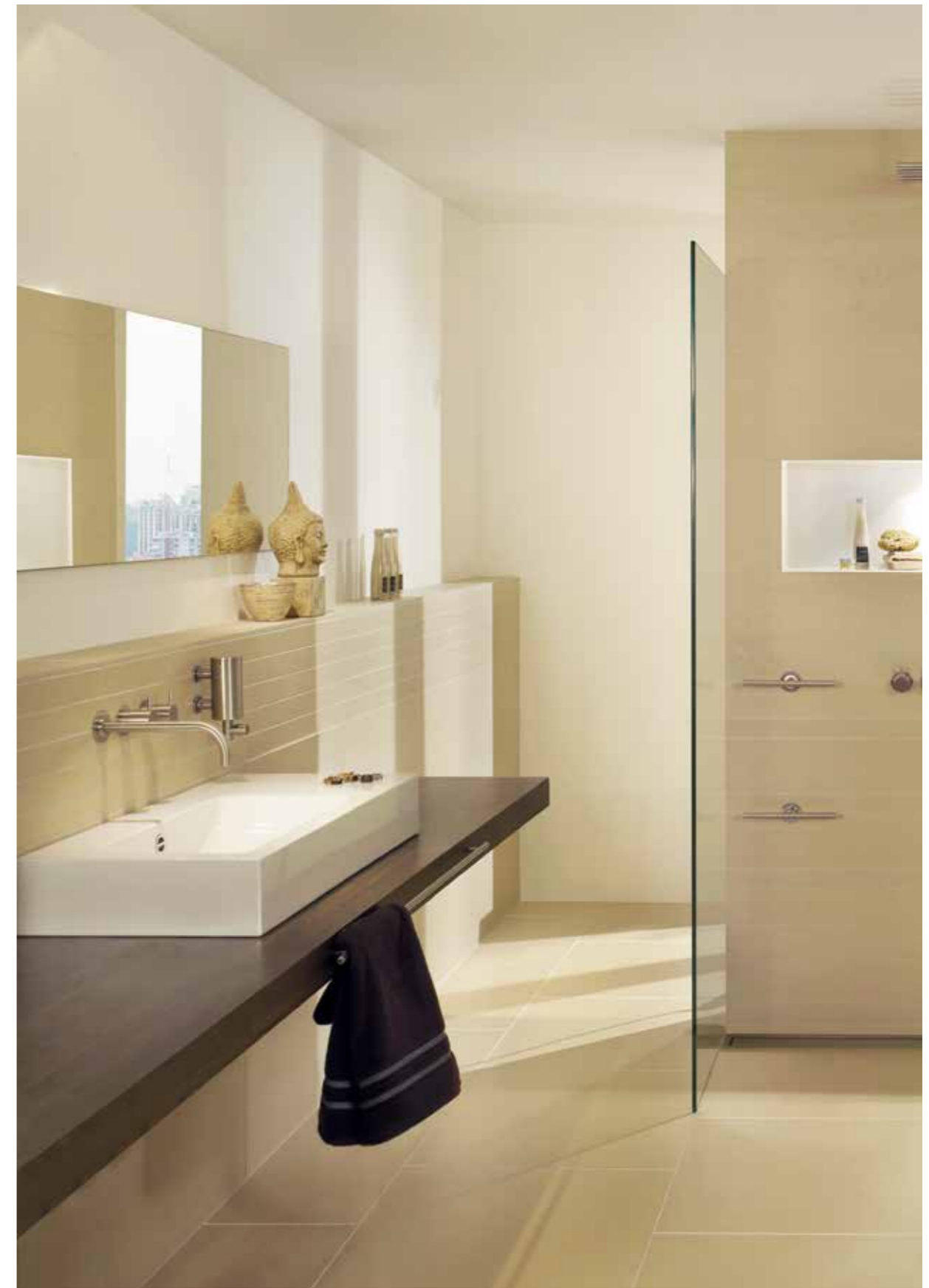

Sizes (cm)	Thickness (mm)	Pieces X	M² X	Kg X	X Eu. Pallet	M² X Eu. Pallet	kg X Eu. Pallet
60x60	9	4	1.44	33	30	43.20	990
30x60	9	6	1.08	24.5	40	43.20	980
mosaic 30x30	9	6	-	9	48	-	432

Surface 2.0



CONCRETE

Surface 2.0

PORCELAIN TILES

Lappato / Matt • Rectified • Smooth / Heavy Structure



surface 2.0 cool grey



surface 2.0 mid grey



surface 2.0 off white



surface 2.0 ash



surface 2.0 sand

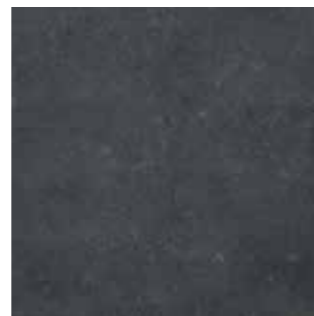

surface 2.0 night



surface 2.0 mix decor
30x30 cm

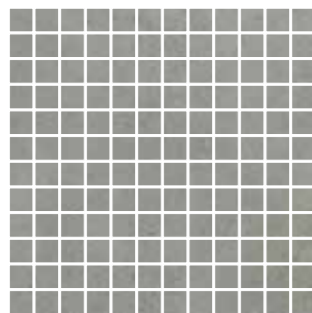

surface 2.0 cool grey
mosaic 2.5x2.5

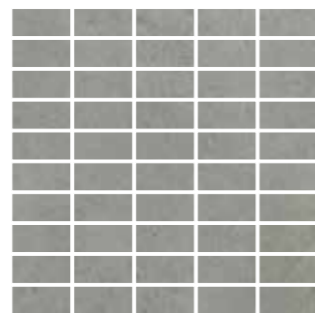

surface 2.0 cool grey
mosaic 3x6

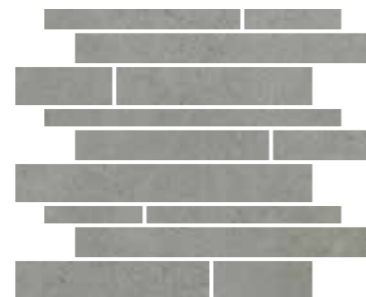

surface 2.0 cool grey
brick mosaic 30x30cm

SIZES



135x305 cm*
>|< 14.5 mm

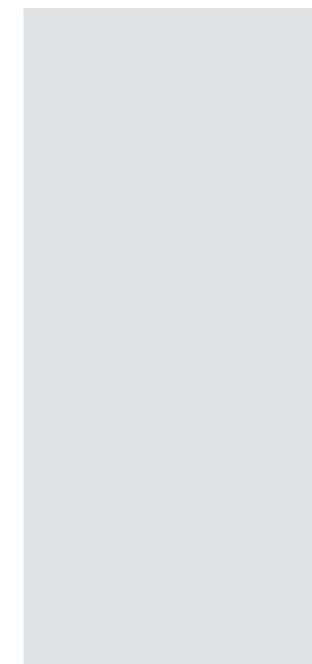

120x260 cm*

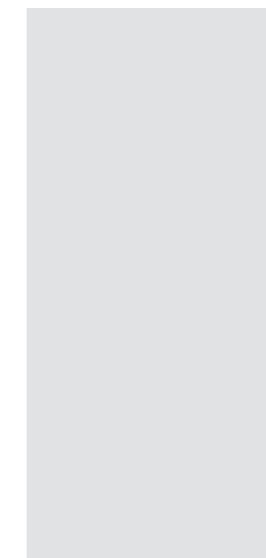

120x120 cm*

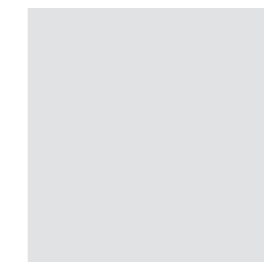

80x80 cm

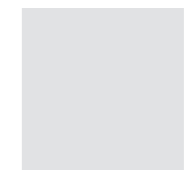

60x120 cm



60x60 cm



30x60 cm

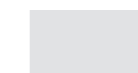

mosaic 2.5x2.5
30x30 cm



mosaic 3x6
30x30 cm



brick mosaic
30x30 cm



Available in a matching outdoor range – see page 236.

Available as a countertop – see page 182.

*Available in cool grey, off white and sand, in a matt finish only.

FINISHES



lappato



matt

Surface 2.0

matt		matt		
Name	Code	Code	Size(CM)	
surface 2.0 cool grey	AGB83ZSFXCZYMSNLR	135x305	AGB62ZSFXYGRYZMSNLR	120x260
surface 2.0 off white	AGB83ZSFOWHZMSNLR	135x305	AGB62ZSFYHOWZMSNLR	120x260
surface 2.0 sand	AGB83ZSFXSANZMSNLR	135x305	AGB62ZSFXWHTZMSNLR	120x260

matt		
Name	Code	Size(CM)
surface 2.0 cool grey	AI22GSFX-CGY.MoC3R	120x120
surface 2.0 off-white	AI22GSFX-OWH.MoC3R	120x120
surface 2.0 sand	AI22GSFX-SN.MoC3R	120x120

lappato		matt		
Name	Code	Size(CM)	Code	Size(CM)
surface 2.0 cool grey	A12GZSUR-CGY.MoS5L	60x120	A12GZSUR-CGY.MoS5R	60x120
surface 2.0 mid grey	A12GZSUR-MGY.MoS5L	60x120	A12GZSUR-MGY.MoS5R	60x120
surface 2.0 off white	A12GZSUR-OWH.MoS5L	60x120	A12GZSUR-OWH.MoS5R	60x120
surface 2.0 ash	A12GZSUR-ASo.MoS5L	60x120	A12GZSUR-ASo.MoS5R	60x120
surface 2.0 sand	A12GZSUR-SNo.MoS5L	60x120	A12GZSUR-SNo.MoS5R	60x120
surface 2.0 night	A12GZSUR-NTo.MoS9L	60x120	A12GZSUR-NTo.MoS5R	60x120

matt		
Name	Code	Size(CM)
surface 2.0 cool grey	Ao5GZSUR-CGY.MoXoR	80x80
surface 2.0 mid grey	Ao5GZSUR-MGY.MoXoR	80x80
surface 2.0 off-white	Ao5GZSUR-OWH.MoXoR	80x80
surface 2.0 ash	Ao5GZSUR-ASH.MoXoR	80x80
surface 2.0 sand	Ao5GZSUR-SND.MoXoR	80x80

lappato		matt		
Name	Code	Size(CM)	Code	Size(CM)
surface 2.0 cool grey	Ao6GZSUR-CGY.MoL	60x60	Ao6GZSUR-CGY.MoR	60x60
surface 2.0 mid grey	Ao6GZSUR-MGY.MoL	60x60	Ao6GZSUR-MGY.MoR	60x60
surface 2.0 off white	Ao6GZSUR-OWH.MoL	60x60	Ao6GZSUR-OWH.MoR	60x60
surface 2.0 ash	Ao6GZSUR-ASo.MoL	60x60	Ao6GZSUR-ASo.MoR	60x60
surface 2.0 sand	Ao6GZSUR-SNo.MoL	60x60	Ao6GZSUR-SNo.MoR	60x60
surface 2.0 night	Ao6GZSUR-NTo.MoL	60x60	Ao6GZSUR-NTo.MoR	60x60

lappato		matt		
Name	Code	Size(CM)	Code	Size(CM)
surface 2.0 cool grey	Ao9GZSUR-CGY.MoL	30x60	Ao9GZSUR-CGY.MoR	30x60
surface 2.0 mid grey	Ao9GZSUR-MGY.MoL	30x60	Ao9GZSUR-MGY.MoR	30x60
surface 2.0 off white	Ao9GZSUR-OWH.MoL	30x60	Ao9GZSUR-OWH.MoR	30x60
surface 2.0 ash	Ao9GZSUR-ASo.MoL	30x60	Ao9GZSUR-ASo.MoR	30x60
surface 2.0 sand	Ao9GZSUR-SNo.MoL	30x60	Ao9GZSUR-SNo.MoR	30x60
surface 2.0 night	Ao9GZSUR-NTo.MoL	30x60	Ao9GZSUR-NTo.MoR	30x60

Name	Code	Size(CM)
surface 2.0 mosaic mix decor	AooGzSUR-MIX.MDR	30x30

Name	Code	Size(CM)
surface 2.0 cool grey mosaic 2.5x2.5	AM-GZSUR-CG.RT/2H	30x30
surface 2.0 mid grey mosaic 2.5x2.5	AM-GZSUR-MG.RT/2H	30x30
surface 2.0 off white mosaic 2.5x2.5	AM-GZSUR-OW.RT/2H	30x30
surface 2.0 ash mosaic 2.5x2.5	AM-GZSUR-AS.RT/2H	30x30
surface 2.0 sand mosaic 2.5x2.5	AM-GZSUR-SN.RT/2H	30x30
surface 2.0 night mosaic 2.5x2.5	AM-GZSUR-NT.RT/2H	30x30

Name	Code	Size(CM)
surface 2.0 cool grey mosaic 3x6	AM-GZSUR-CG.RT3/6	30x30
surface 2.0 mid grey mosaic 3x6	AM-GZSUR-MG.RT3/6	30x30
surface 2.0 off white mosaic 3x6	AM-GZSUR-OW.RT3/6	30x30
surface 2.0 ash mosaic 3x6	AM-GZSUR-AS.RT3/6	30x30
surface 2.0 sand mosaic 3x6	AM-GZSUR-SN.RT3/6	30x30
surface 2.0 night mosaic 3x6	AM-GZSUR-NT.RT3/6	30x30

lappato		matt		
Name	Code	Size(CM)	Code	Size(CM)
surface 2.0 cool grey brick mosaic	AM-GZSUR-CG.LP/BRK	30x30	AM-GZSUR-CG.RT/BRK	30x30
surface 2.0 mid grey brick mosaic	AM-GZSUR-MG.LP/BRK	30x30	AM-GZSUR-MG.RT/BRK	30x30
surface 2.0 off white brick mosaic	AM-GZSUR-OW.LP/BRK	30x30	AM-GZSUR-OW.RT/BRK	30x30
surface 2.0 ash brick mosaic	AM-GZSUR-AS.LP/BRK	30x30	AM-GZSUR-AS.RT/BRK	30x30
surface 2.0 sand brick mosaic	AM-GZSUR-SN.LP/BRK	30x30	AM-GZSUR-SN.RT/BRK	30x30
surface 2.0 night brick mosaic	AM-GZSUR-NT.LP/BRK	30x30	AM-GZSUR-NT.RT/BRK	30x30

Sizes (cm)	Thickness (mm)	Pieces X	M² X	Kg X	X Eu. Pallet	M² X Eu. Pallet	kg X Eu. Pallet
135x305	14.5	1	4.12	160	10	41.20	1600
120x260	6	1	3.12	48	20	62.40	960
120x120	9	2	2.88	60	22	63.36	1320
80x80	9	2	1.28	25.5	40	51.2	1020
60x120	9	2	1.44	29	30	43.20	891
60x60	9	4	1.44	28	30	43.20	861
30x60	9	6	1.08	23	40	43.20	941
mosaic 30x30	9	10	-	19	48	-	912



Symphony



CONCRETE

Symphony

PORCELAIN TILES

Matt • Straight • Smooth



star 1



star 2



gaudi a



gaudi b

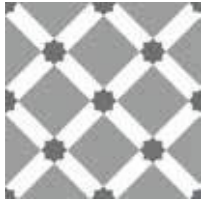

ornamental 1

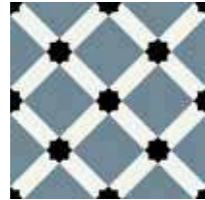

ornamental 2



ornamental 3

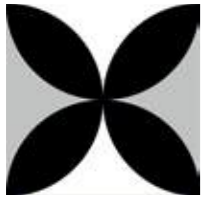

petals a

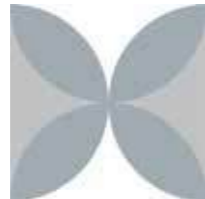

petals b

matt		
Name	Code	Size(CM)
symphony star 1	EBHY103	20x20
symphony star 2	EBHY203	20x20
symphony gaudi a	EBDF103	20x20
symphony gaudi b	EBDF302	20x20
symphony ornamental 1	EBDJ102	20x20
symphony ornamental 2	EBDJ302	20x20
symphony ornamental 3	EBDI102	20x20
symphony petals a	EBDH101	20x20
symphony petals b	EBDH202	20x20

Sizes (cm)	Thickness (mm)	Pieces X	M ² X	Kg X	X Eu. Pallet	M ² X Eu. Pallet	kg X Eu. Pallet
20x20	-	14	0.56	11.55	87	48.72	1004.85

SIZES



20x20 cm

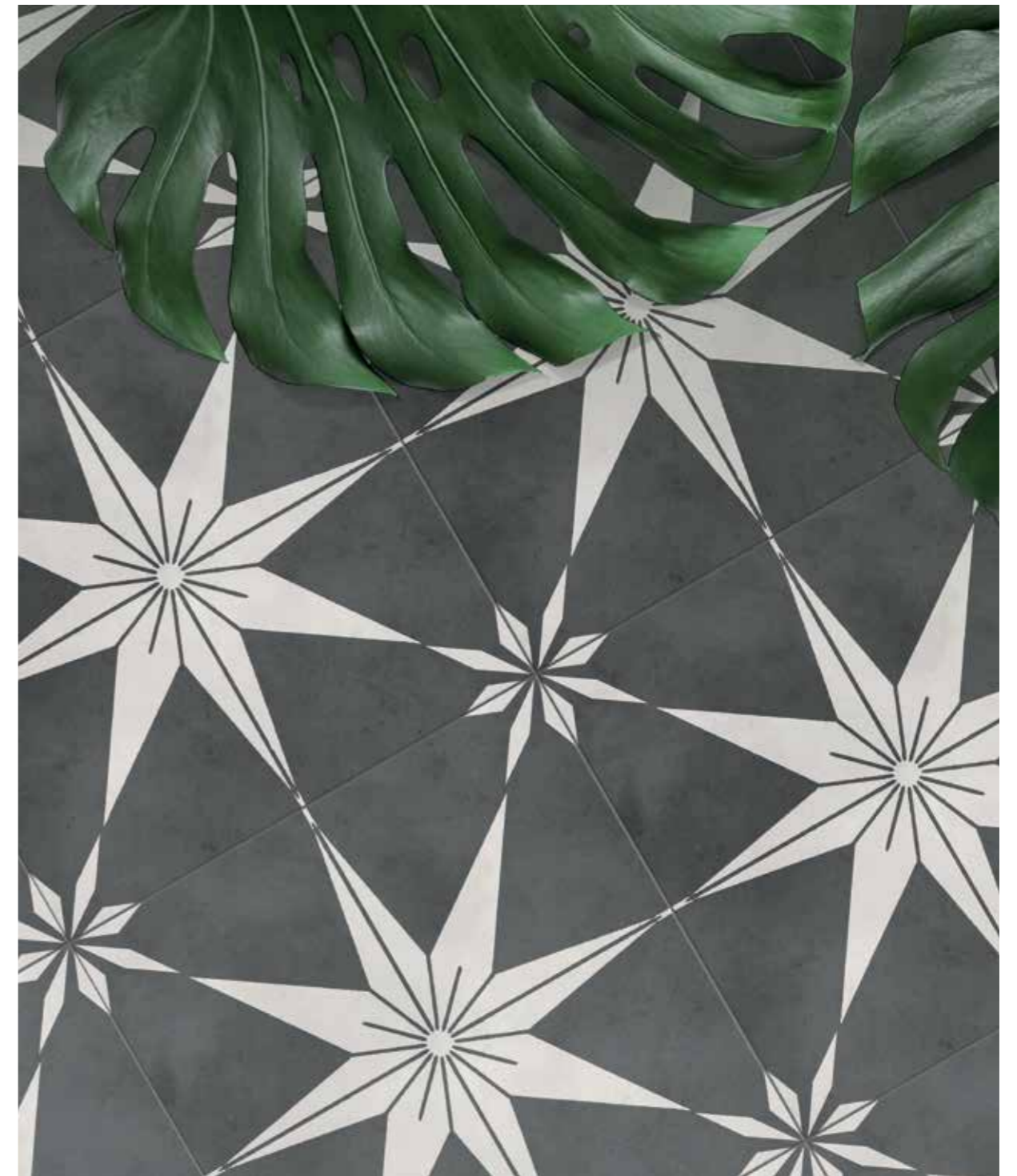

CONCRETE



Countertop

A multifunctional material that makes a statement

The countertop collection is the next generation of large format tiles that are versatile and highly technical. They are perfect for kitchen countertops, vanity tops and furniture application for residential and commercial settings. Through-body veining is our innovative breakthrough in reproducing natural marble and stone veins that pass through the thickness of the slab's body. This technology gives our slabs a unique design feature, having a consistent marble veining, from the surface to the body until the base – a total synchronisation.

Our countertops also come available as a CookingRAK slab, which is designed to create a multifunctional kitchen space ideal for daily use. Integrating the system into the countertop opens up possibilities for users to prepare, cook and dine in the same place.





A one-of-a-kind hidden induction cooking system

CookingRAK is designed to create a multifunctional kitchen space ideal for daily use. Integrating the system into the countertop opens up possibilities for users to prepare, cook and dine in the same space – a seamlessly designed kitchen top made for dining and entertaining. CookingRAK is a technology that combines the high performance of RAK Ceramics porcelain slabs and the innovative induction system that operates through a magnetic field.

Porcelain has always been the ideal choice for kitchen countertops as it's a durable material resistant to heat, stain, and scratch. It's also resistant to moisture and does not easily stain, making it easier to clean. Safety in the kitchen is a matter of great importance, and with CookingRAK's induction system, the countertop surface does not heat up. Instead, as it works using electromagnetic currents, it will only heat the cookware placed over the hob. With remarkable features, CookingRAK will transform any kitchen into a space where the best experiences are lived.

-  CHEMICAL RESISTANT
-  HEAT RESISTANT
-  ENVIRONMENT-FRIENDLY
-  EASY TO CLEAN
-  WATER RESISTANT
-  STAIN RESISTANT
-  HYGIENIC

Countertop Collection

PORCELAIN TILES

Polished / Matt / Honed • Rectified • Smooth



blu del belgio blue



blu del belgio clay



classic carrara grey



medicea marble



uni dark black



calacatta gold white



calacatta africa white

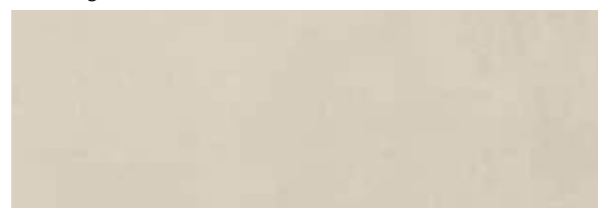

surface xl off white



versilia marble

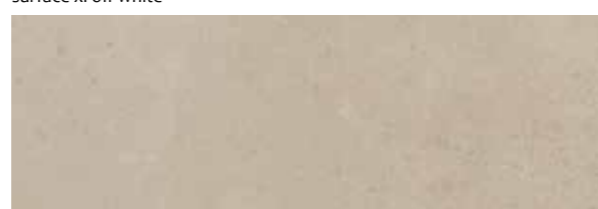

surface xl sand



surface xl cool grey



black beauty



taj mahal



breccia adige grey



SIZES

135x305 cm

>|< 14.5 mm

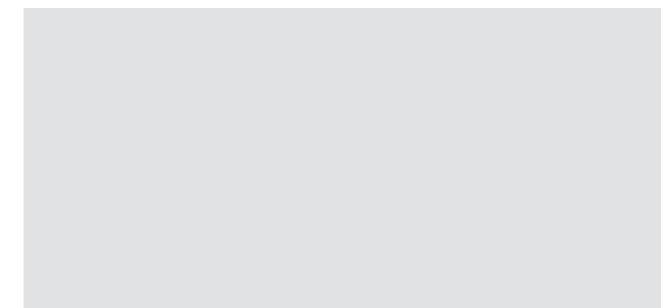

polished			polished		
Name	Code	Size(CM)	Name	Code	Size(CM)
blu del belgio blue	A83GZBLB-BLo.GoC2P	135x305	uni dark black	A83GMAXI-DBK.XoC2P	135x305
blu del belgio clay	A83GZBLB-CLo.GoC2P	135x305	calacatta gold white	A83GCTAG-WHE.NoX2P	135x305
classic carrara grey	A83GZCRR-GYo.GoC2P	135x305	calacatta africa white	A83GCCAF-WHE.NoX2P	135x305
medicea marble	AGB83MDMBWHZHSC2P	135x305	versilia marble	AGB83VSMBWHZHSC2P	135x305

matt			matt		
Name	Code	Size(CM)	Name	Code	Size(CM)
surface xl off white	AGB83ZSFXOWHZMSNLR	135x305	classic carrara grey	A83GZCRR-GRY.MoX2R	135x305
surface xl cool grey	AGB83ZSFXCGVZMSNLR	135x305	black beauty	A83GBBKB-NEO.MoX2R	135x305
surface xl sand	AGB83ZSFXSANZMSNLR	135x305	calacatta africa white	A83GCCAF-WHE.MoX2R	135x305

honed			honed		
Name	Code	Size(CM)	Name	Code	Size(CM)
breccia adige grey	A83GBRAE-GRY.OoX2P	135x305	blu del belgio blue	A83GZBLB-BLE.OoX2P	135x305
taj mahal	A83GTHMH-PRL.OoX2P	135x305	blu del belgio clay	A83GZBLB-CLA.OoX2P	135x305

Sizes (cm)	Thickness (mm)	Pieces X	M² X	Kg X	X Eu. Pallet	M² X Eu. Pallet	Kg X Eu. Pallet
135x305	14.5	1	4.12	160	10	41.20	1600



Ceramic Wall Tiles

The only limit is imagination

With the continuous innovation in ceramic technology and research, all types of surfaces can now be reproduced: natural wood effect, ceramic wallpaper, metal effect, concrete coatings and more.

Our new ceramic tile collections meet the latest trends, achieving original and eye-catching aesthetic results, with a wide range of structures and colours: from the latest pastel tones to the most intense material effects.

The range of possibilities becomes even bigger, thanks to the wide choice of sizes, from the small brick to the large tile. It's ceramics, and it's cool!

Carrara

WHITE BODY CERAMIC TILES

Lappato / Matt • Straight • Smooth / Heavy Structure



carrara grey

SIZES



30x60 cm

45x45 cm

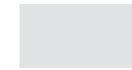

lappato		matt	
Name	Code	Code	Size(CM)
carrara grey	R819	C431	45x45

Sizes (cm)	Thickness (mm)	Pieces X	M² X	Kg X	X Eu. Pallet	M² X Eu. Pallet	kg X Eu. Pallet
30x60	8	8	1.46	21	32	46.72	672
45x45	8.5	5	1.01	18	36	36.36	671

Chiltern



CERAMIC WALL TILES

Chiltern

WHITE BODY CERAMIC TILES

Matt • Straight • Smooth / Heavy Structure



anthracite



greige



grey



muretto mix anthracite



muretto mix greige

matt		
Name	Code	Size(CM)
chiltern grey	P6102	60x60

matt		
Name	Code	Size(CM)
chiltern grey	R3735	30x60
chiltern anthracite	R3736	30x60
chiltern greige	R3734	30x60
chiltern muretto mix anthracite	R3738	30x60
chiltern muretto mix greige	R3737	30x60

Sizes (cm)	Thickness (mm)	Pieces X	M² X	Kg X	X Eu. Pallet	M² X Eu. Pallet	kg X Eu. Pallet
60x60	8	3	1.08	24	36	38.88	876
30x60	8	8	1.46	21	32	46.72	672

SIZES



60x60 cm



30x60 cm



CERAMIC WALL TILES

Cumbria



CERAMIC WALL TILES

Cumbria

WHITE BODY CERAMIC TILES / PORCELAIN TILES

Matt • Straight • Smooth / Heavy Structure



ivory oyster ash sand iron



cubic ivory cubic oyster cubic ash



groove ivory groove oyster groove ash

matt			
Name	Code	Size(CM)	
cumbria sand	PE005	45x45	
cumbria iron	PE006	45x45	

matt			
Name	Code	Size(CM)	
cumbria ivory	R3657	30x60	
cumbria oyster	R3658	30x60	
cumbria ash	R3659	30x60	
cumbria cubic ivory	R3662	30x60	
cumbria cubic oyster	R3663	30x60	
cumbria cubic ash	R3664	30x60	
cumbria groove ivory	R3666	30x60	
cumbria groove oyster	R3667	30x60	
cumbria groove ash	R3668	30x60	

Sizes (cm)	Thickness (mm)	Pieces X	M² X	Kg X	X Eu. Pallet	M² X Eu. Pallet	kg X Eu. Pallet
45x45	8	5	1.01	19	36	36.36	711
30x60	8	8	1.46	21	32	46.72	672

SIZES



45x45 cm*

30x60 cm**



*All 45x45 cm tiles are porcelain floor tiles.
**All 30x60 cm tiles are ceramic wall tiles.



CERAMIC WALL TILES

Marakkesh

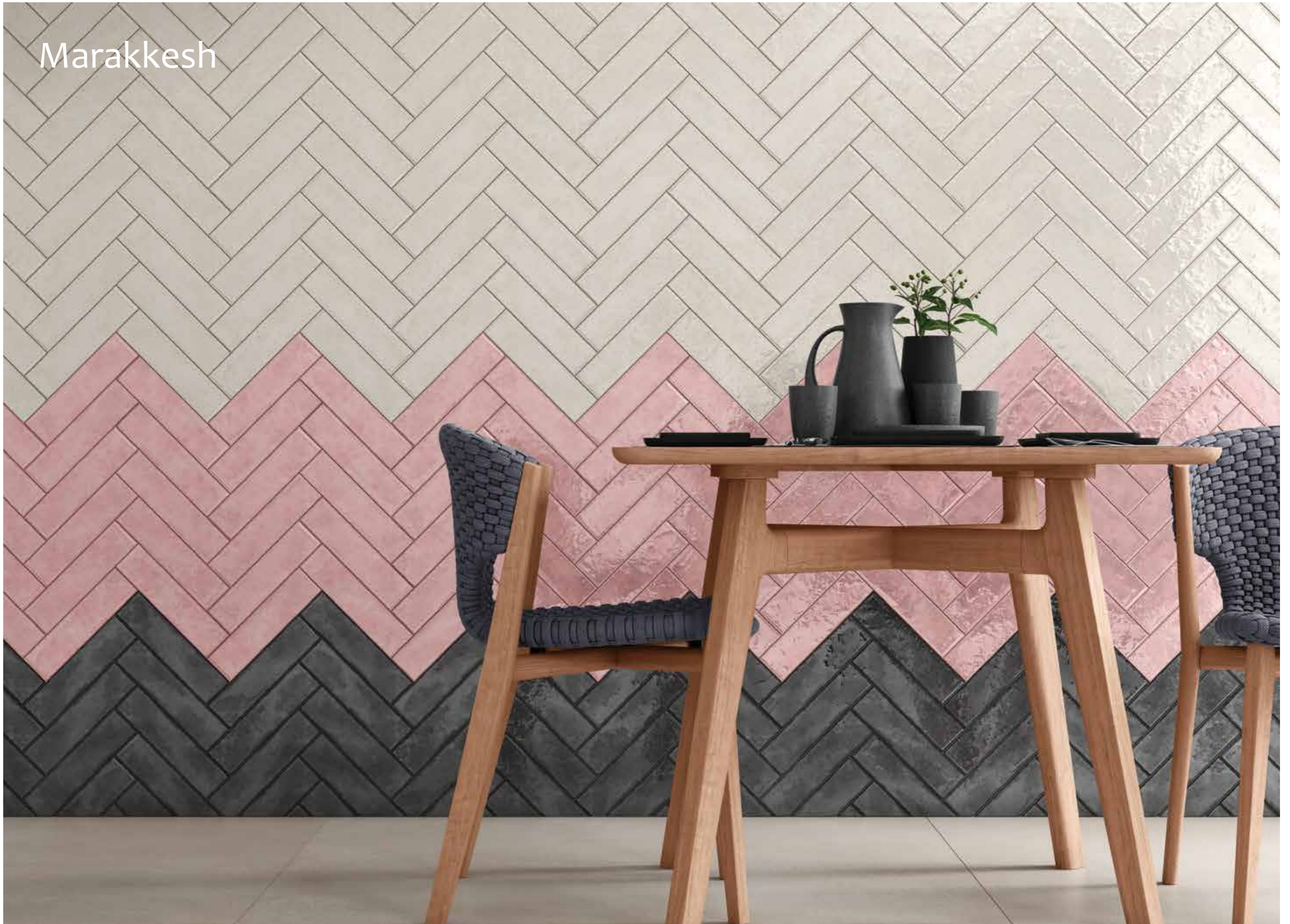

CERAMIC WALL TILES

Marakkesh

WHITE BODY CERAMIC TILES / GRES WHITE BODY TILES
Glossy • Straight • Light Structure



Name	glossy		glossy	
	Code	Size(CM)	Code	Size(CM)
marakkesh ash	A42WMRKS-ASH.G6XoU	6.5x26	A15SMRKS-ASH.G6XoU	15x15
marakkesh grey	A42WMRKS-GRY.G6XoU	6.5x26	A15SMRKS-GRY.G6XoU	15x15
marakkesh dark grey	A42WMRKS-DKG.G6XoU	6.5x26	A15SMRKS-DKG.G6XoU	15x15
marakkesh greige	A42WMRKS-GRG.G6XoU	6.5x26	A15SMRKS-GRG.G6XoU	15x15
marakkesh green	A42WMRKS-GRE.G6XoU	6.5x26	A15SMRKS-GRE.G6XoU	15x15
marakkesh dark blue	A42WMRKS-DAB.G6XoU	6.5x26	A15SMRKS-DAB.G6XoU	15x15
marakkesh light blue	A42WMRKS-LIB.G6XoU	6.5x26	A15SMRKS-LIB.G6XoU	15x15
marakkesh white	A42WMRKS-WHE.G6XoU	6.5x26	A15SMRKS-WHE.G6XoU	15x15
marakkesh brown	A42WMRKS-BRN.G6XoU	6.5x26	A15SMRKS-BRN.G6XoU	15x15
marakkesh dark pink	A42WMRKS-DEP.G6XoU	6.5x26	A15SMRKS-DEP.G6XoU	15x15
marakkesh pink	A42WMRKS-PIK.G6XoU	6.5x26	A15SMRKS-PIK.G6XoU	15x15
marakkesh ivory	A42WMRKS-IVO.G6XoU	6.5x26	A15SMRKS-IVO.G6XoU	15x15

Sizes (cm)	Thickness (mm)	Pieces X	M² X	Kg X	X Eu. Pallet	M² X Eu. Pallet	kg X Eu. Pallet
15x15	6.5	48	1.08	16.5	51	55.08	836
6.5x26	8.5	41	0.70	10.5	90	63	966

SIZES



15x15 cm 6.5x26 cm



CERAMIC WALL TILES

Monza



Monza

WHITE BODY CERAMIC TILES

Matt • Straight • Smooth / Heavy Structure



white

grey

anthracite



hidra grey

matt		
Name	Code	Size(CM)
monza white	C450	45x45
monza grey	C451	45x45
monza anthracite	C452	45x45

matt		
Name	Code	Size(CM)
monza white	R850	30x60
monza grey	R851	30x60
monza anthracite	R852	30x60
monza hidra grey	R858	30x60

Sizes (cm)	Thickness (mm)	Pieces X	M ² X	Kg X	X Eu. Pallet	M ² X Eu. Pallet	kg X Eu. Pallet
45x45	8	5	1.01	18	36	36.36	671
30x60	8	8	1.44	21	32	46.08	672

SIZES



45x45 cm

30x60 cm

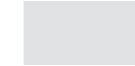
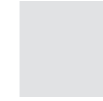

Sensation White

WHITE BODY CERAMIC TILES
Glossy / Matt • Straight • Smooth

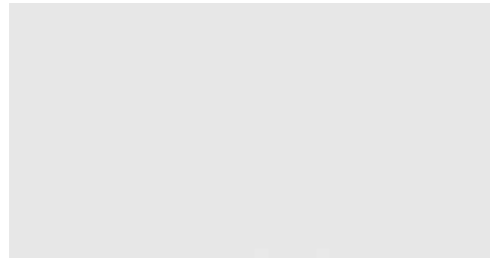

sensation white

FINISHES

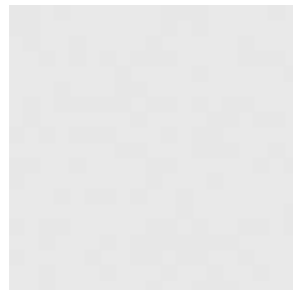

glossy

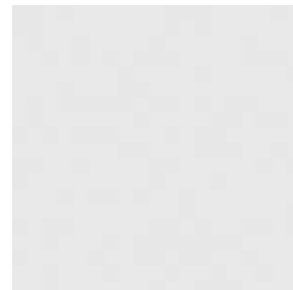

matt

glossy				matt			
Name	Code	Size(CM)		Code	Size(CM)		
sensation white	A14WSUPR-WHo.HoS4R/D	30x60		A14WSUPR-WHo.MoS4R/D	30x60		

Sizes (cm)	Thickness (mm)	Pieces X	M ² X	Kg X	X Eu. Pallet	M ² X Eu. Pallet	kg X Eu. Pallet
30x60	8	9	1.62	21	40	64.8	840

SIZES



30x60 cm

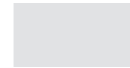

Subway

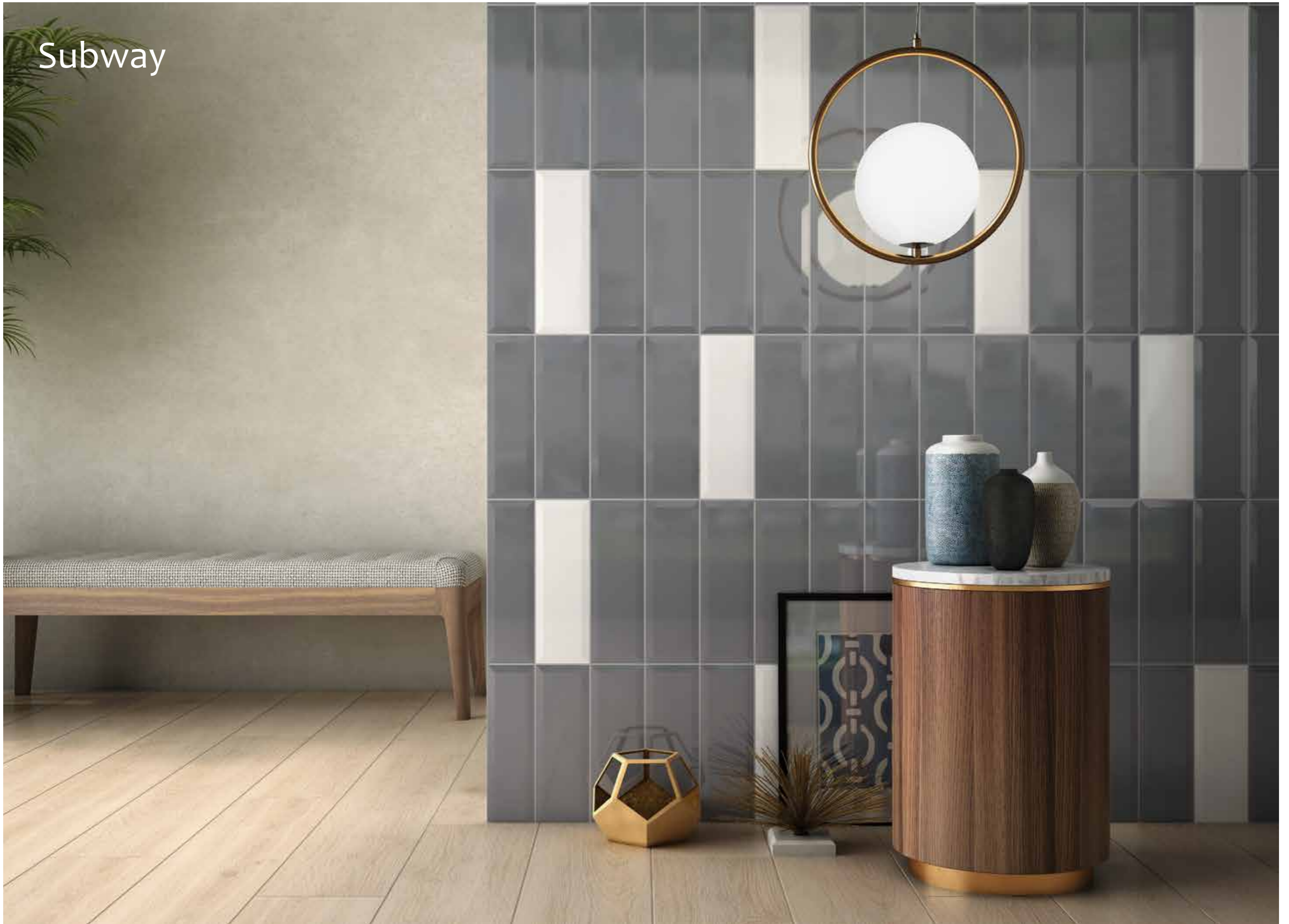

CERAMIC WALL TILES

Subway

WHITE BODY CERAMIC TILES / GRES WHITE BODY TILES
Glossy / Matt • Straight • Smooth / Heavy Structure

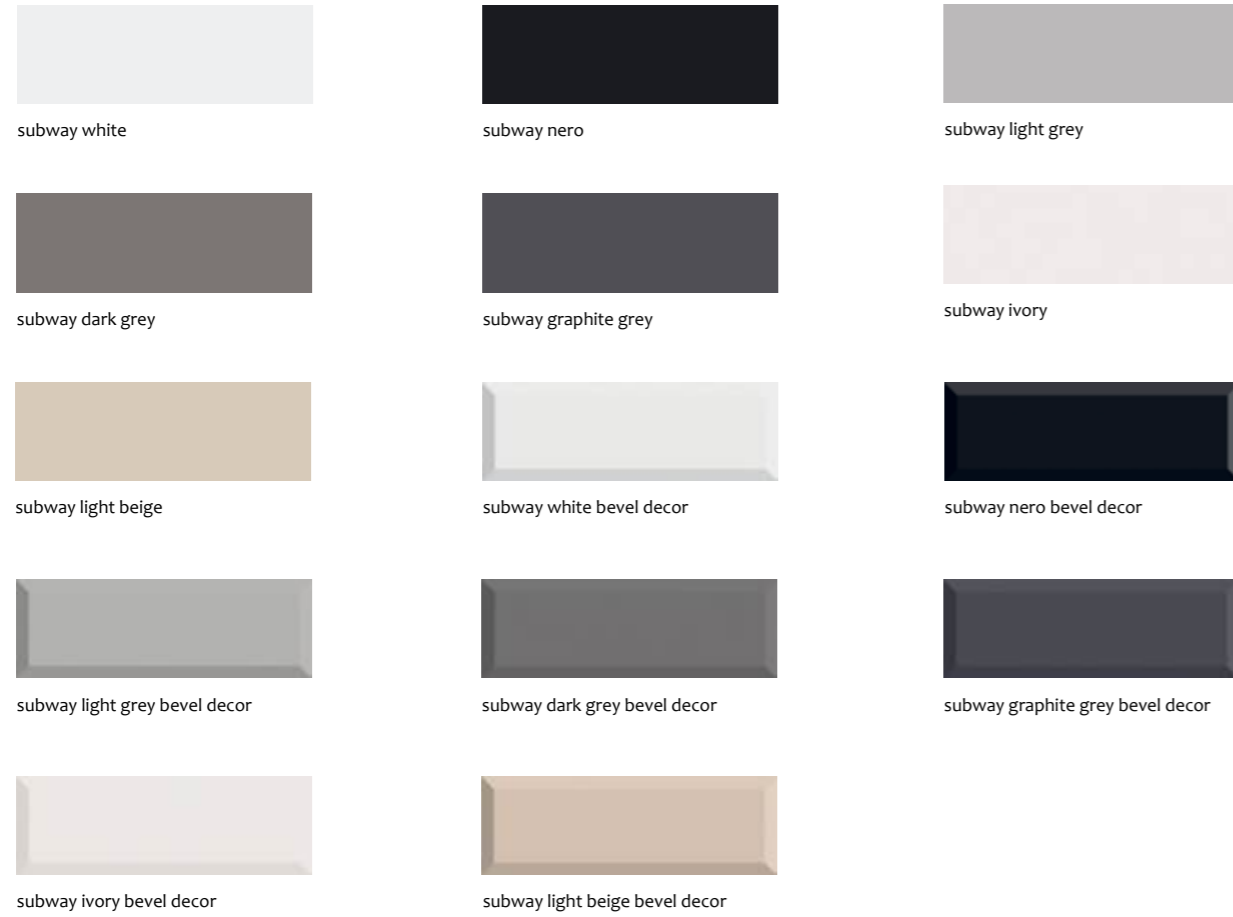

FINISHES

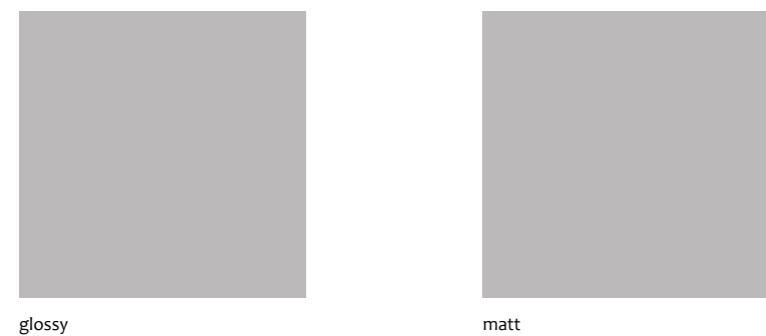

Sizes (cm)	Thickness (mm)	Pieces X	M² X	Kg X	X Eu. Pallet	M² X Eu. Pallet	kg X Eu. Pallet
10x30	8,5	27	0,81	12,5	77	62,37	983,5
6,5x26	8,5	41	0,70	10,5	90	63	966

SIZES

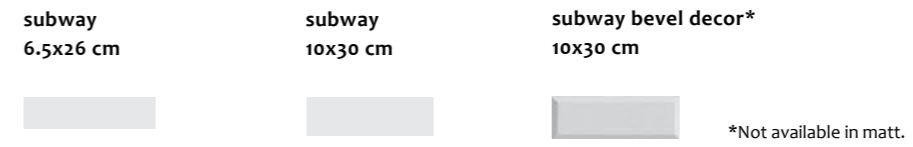

glossy			matt	
Name	Code	Size(CM)	Code	Size(CM)
subway white	A42WSUBY-WHE.GoXoU	6,5x26	A42WSUBY-WHE.MoXoU	6,5x26
subway nero	A42WSUBY-NEO.GoXoU	6,5x26	A42WSUBY-NEO.MoXoU	6,5x26
subway graphite grey	A42WSUBY-GPG.GoXoU	6,5x26	A42WSUBY-GPG.MoXoU	6,5x26
subway light grey	A42WSUBY-GRY.GoXoU	6,5x26	A42WSUBY-GRY.MoXoU	6,5x26
subway dark grey	A42WSUBY-DKG.GoXoU	6,5x26	A42WSUBY-DKG.MoXoU	6,5x26
subway ivory	A42WSUBY-IVO.GoXoU	6,5x26	A42WSUBY-IVO.MoXoU	6,5x26
subway light beige	A42WSUBY-LBE.GoXoU	6,5x26	A42WSUBY-LBE.MoXoU	6,5x26

glossy			matt	
Name	Code	Size(CM)	Code	Size(CM)
subway white	A13WSUBY-WHE.GoXoU	10x30	A13WSUBY-WHE.MoXoU	10x30
subway nero	A13WSUBY-NEO.GoXoU	10x30	A13WSUBY-NEO.MoXoU	10x30
subway graphite grey	A13WSUBY-GPG.GoXoU	10x30	A13WSUBY-GPG.MoXoU	10x30
subway light grey	A13WSUBY-GRY.GoXoU	10x30	A13WSUBY-GRY.MoXoU	10x30
subway dark grey	A13WSUBY-DKG.GoXoU	10x30	A13WSUBY-DKG.MoXoU	10x30
subway ivory	A13WSUBY-IVO.GoXoU	10x30	A13WSUBY-IVO.MoXoU	10x30
subway light beige	A13WSUBY-LBE.GoXoU	10x30	A13WSUBY-LBE.MoXoU	10x30

glossy		
Name	Code	Size(CM)
subway white bevel decor	A13WSUBY-WHE.GBX4U	10x30
subway nero bevel decor	A13WSUBY-NEO.GBX4U	10x30
subway graphite grey bevel decor	A13WSUBY-GPG.GBX4U	10x30
subway light grey bevel decor	A13WSUBY-GRY.GBX4U	10x30
subway dark grey bevel decor	A13WSUBY-DKG.GBX4U	10x30
subway ivory bevel decor	A13WSUBY-IVO.GBX4U	10x30
subway light beige bevel decor	A13WSUBY-LBE.GBX4U	10x30

Warwick



CERAMIC WALL TILES

Warwick

WHITE BODY CERAMIC TILES

Matt • Straight • Smooth / Heavy Structure



white

beige

grey



white decor

beige decor

grey decor

matt		
Name	Code	Size(CM)
warwick white	C425	45x45
warwick beige	C426	45x45
warwick grey	C427	45x45

matt		
Name	Code	Size(CM)
warwick white	R3695	30x60
warwick beige	R3696	30x60
warwick grey	R3697	30x60
warwick white decor	R3701	30x60
warwick beige decor	R3702	30x60
warwick grey decor	R3703	30x60

Sizes (cm)	Thickness (mm)	Pieces X	M² X	Kg X	X Eu. Pallet	M² X Eu. Pallet	kg X Eu. Pallet
45x45	8	5	1.01	18	36	36.36	671
30x60	8	8	1.46	21	32	46.72	672

SIZES



45x45 cm



30x60 cm

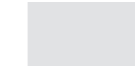



Outdoor

Redefining outdoor living

Give your outdoor spaces a new look. Sustainable and adaptable, porcelain tiles are the ideal choice to design and revamp gardens, patios, terraces, driveways or pool edges. The different installation possibilities allow the material to perfectly blend in with its surrounding landscape.

Carmo Stone

PORCELAIN TILES

Matt • Rectified • Light Structure



carmo stone grey



carmo stone anthracite



carmo stone ivory



carmo stone black

All colours are available in 12 faces

Name	R11 Code	Size(CM)
carmo stone grey	A12GCMSO-GRY.Y6X7R	60x120 (R11)
carmo stone anthracite	A12GCMSO-ANT.Y6X7R	60x120 (R11)
carmo stone ivory	A12GCMSO-IVO.Y6X7R	60x120 (R11)
carmo stone black	A12GCMSO-BLK.Y6X7R	60x120 (R11)

Sizes (cm)	Thickness (mm)	Pieces X	M ² X	Kg X	X Eu. Pallet	M ² X Eu. Pallet	kg X Eu. Pallet
60x120	20	1	0.72	30	30	21.6	900

SIZES



60x120 cm

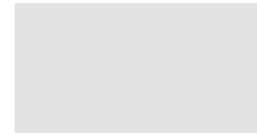

20 MM THICKNESS

Available in a matching indoor range – see page 116.

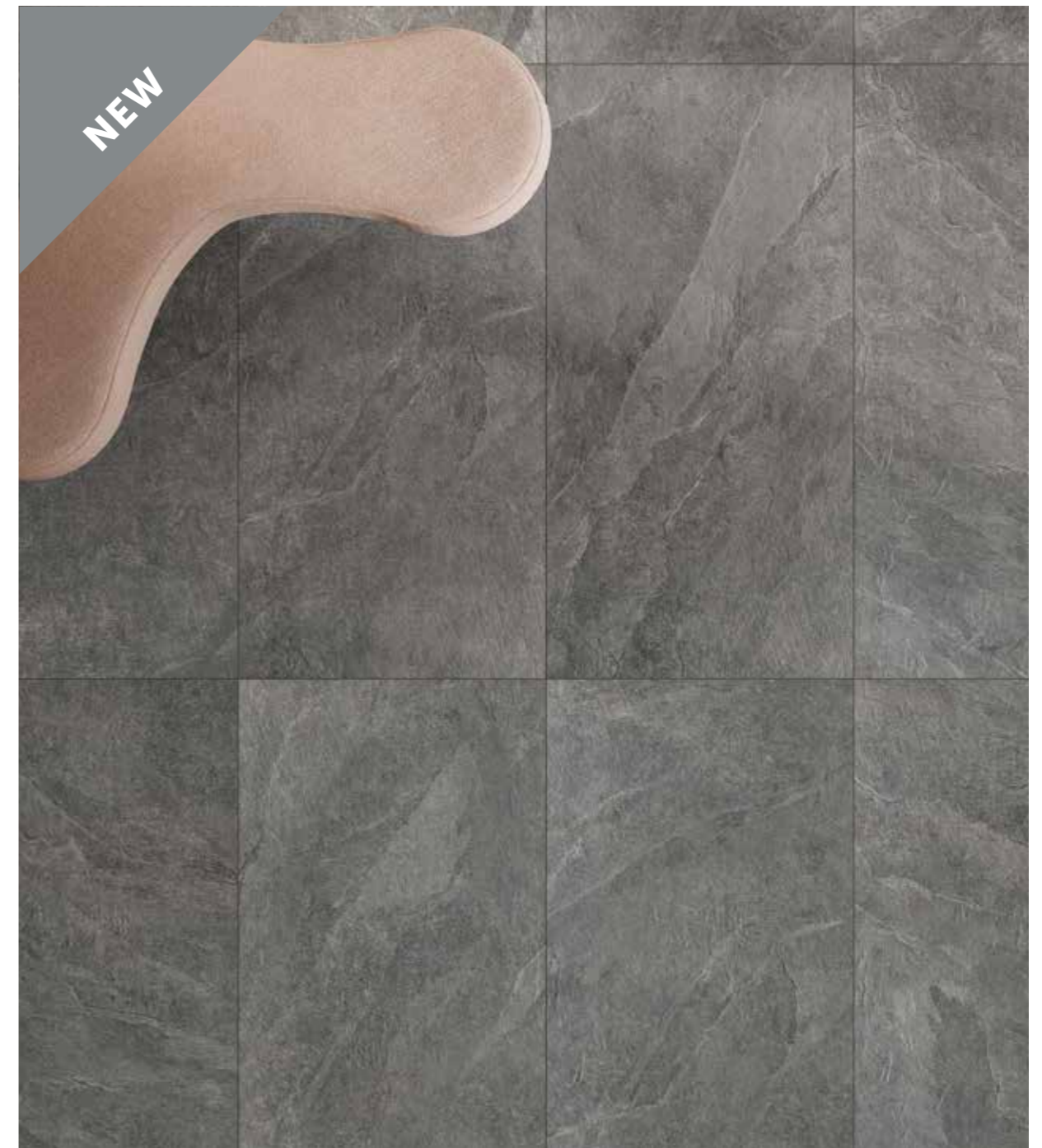

Calacatta Gold

PORCELAIN TILES

Matt • Rectified • Smooth



calacatta gold white

Name		R11		Code		Size(CM)	
calacatta gold white		A12GGDCL-WHE.YoX7R		60x120 (R11)			
Sizes (cm)	Thickness (mm)	Pieces X	M ² X	Kg X	X Eu. Pallet	M ² X Eu. Pallet	kg X Eu. Pallet
60x120	20	1	0.72	33	30	21.6	990

SIZES



60x120 cm

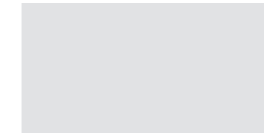

20 MM THICKNESS

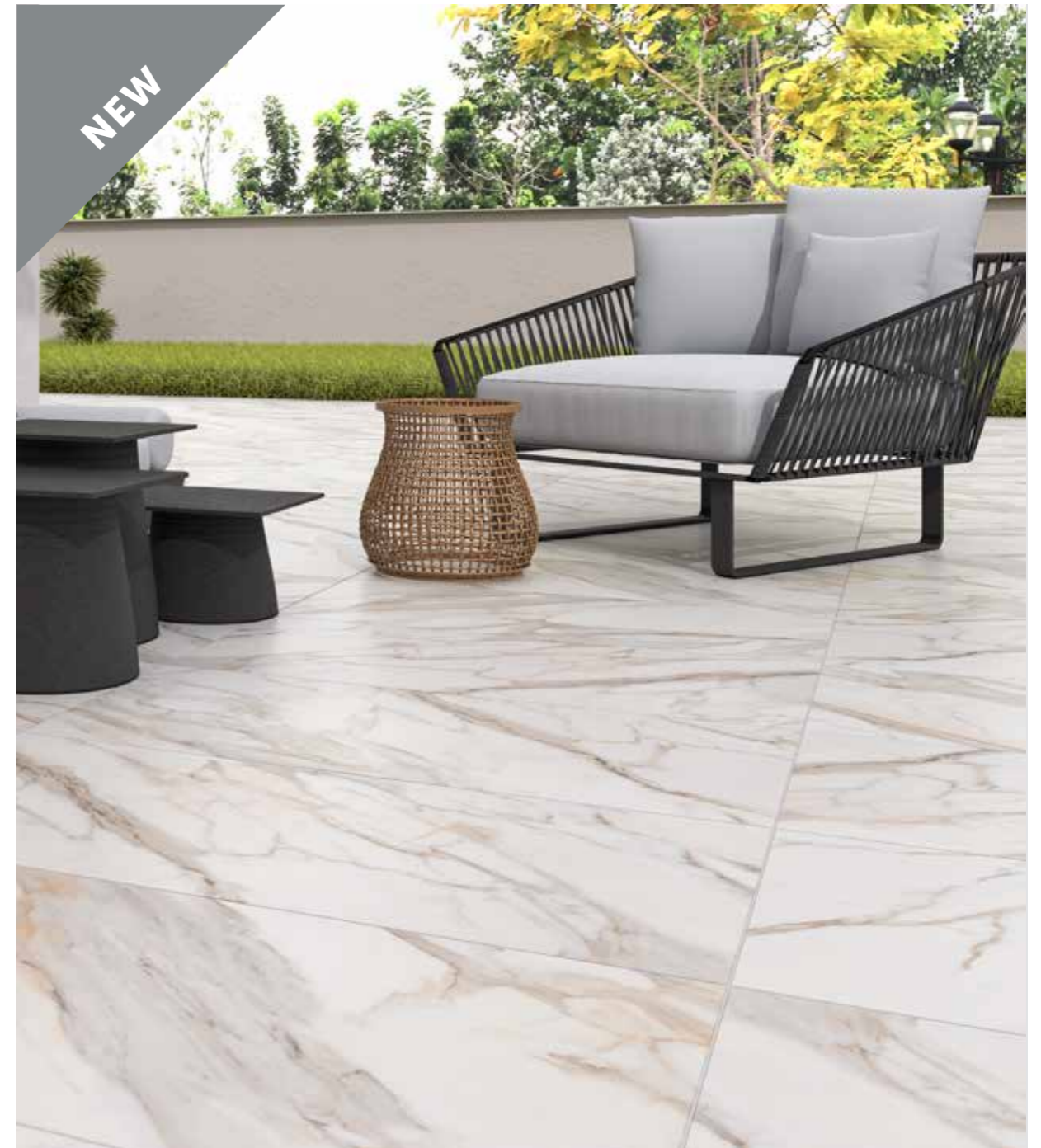
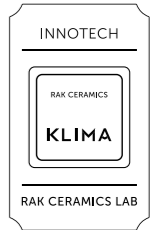

Calacatta Grey

PORCELAIN TILES

Matt • Rectified • Smooth



calacatta grey white

Name		R11		Code		Size(CM)	
calacatta grey white		A12GGRL-WHE.Y0X7R		60x120 (R11)			
Sizes (cm)	Thickness (mm)	Pieces X	M ² X	Kg X	X Eu. Pallet	M ² X Eu. Pallet	kg X Eu. Pallet
60x120	20	1	0.72	33	30	21.6	990

SIZES



60x120 cm

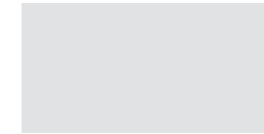

20 MM THICKNESS

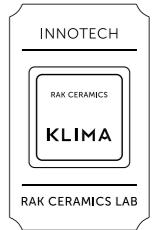

Fashion Stone Outdoor

PORCELAIN TILES

Matt • Rectified • Smooth



fashion stone light grey



fashion stone grey



fashion stone black



fashion stone ivory



fashion stone beige



fashion stone clay

Name	R11 Code	Size(CM)
fashion stone light grey	A06GFNSE-LIG.MYX7R	60x60 (R11)
fashion stone grey	A06GFNSE-GRY.MYX7R	60x60 (R11)
fashion stone black	A06GFNSE-BLK.MYX7R	60x60 (R11)
fashion stone ivory	A06GFNSE-IVO.MYX7R	60x60 (R11)
fashion stone beige	A06GFNSE-BEE.MYX7R	60x60 (R11)
fashion stone clay	A06GFNSE-CLA.MYX7R	60x60 (R11)

Sizes (cm)	Thickness (mm)	Pieces X	M ² X	Kg X	X Eu. Pallet	M ² X Eu. Pallet	kg X Eu. Pallet
60x60	20	2	0.72	32	30	21.6	981

SIZES



60x60 cm



20 MM THICKNESS

Available in a matching indoor range – see page 132.



Maremma

PORCELAIN TILES

Matt • Rectified • Smooth

SIGNATURE
COLLECTION



maremma sand

maremma grey

maremma copper

R11		
Name	Code	Size(CM)
maremma sand	A12GMRMA-SND.Y6X7R	60x120 (R11)
maremma grey	A12GMRMA-GRY.Y6X7R	60x120 (R11)
maremma copper	A12GMRMA-COP.Y6X7R	60x120 (R11)

Sizes (cm)	Thickness (mm)	Pieces X	M ² X	Kg X	X Eu. Pallet	M ² X Eu. Pallet	kg X Eu. Pallet
60x120	20	1	0.72	33	30	21.6	990

SIZES



60x120 cm

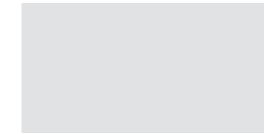

20 MM THICKNESS

Available in a matching indoor range – see page 140.

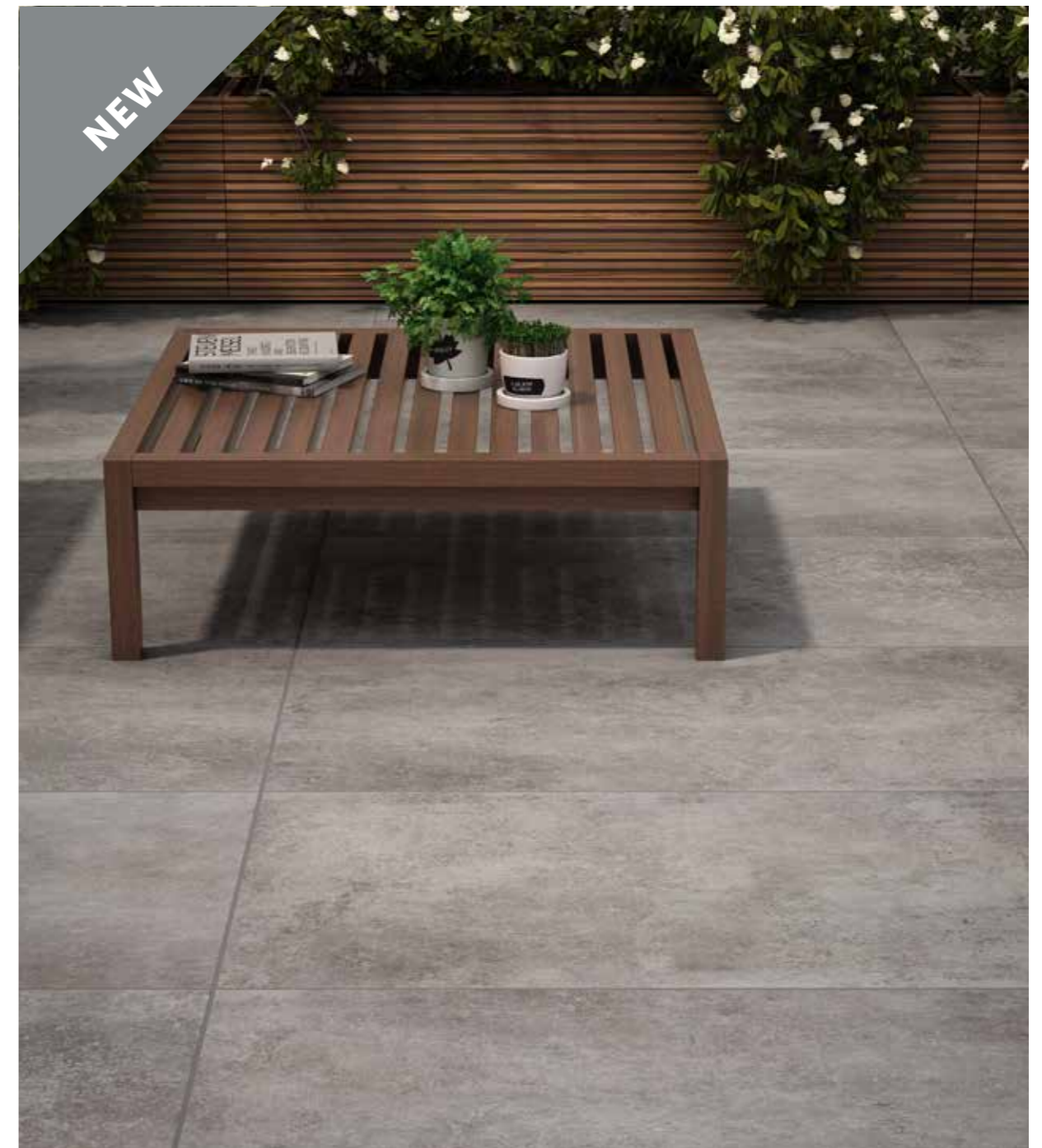
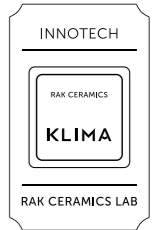

RAK Stone 2.0

PORCELAIN TILES

Matt • Rectified • Smooth



RAK stone 2.0 grey

R11							
Name	Code		Size(CM)				
RAK stone 2.0 grey	A12GRTOE-GRY.Y6X7R		60x120 (R11)				
Sizes (cm)	Thickness (mm)	Pieces X	M² X	Kg X	X Eu. Pallet	M² X Eu. Pallet	kg X Eu. Pallet
60x120	20	1	0.72	33	30	21.6	990

SIZES

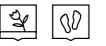

60x120 cm

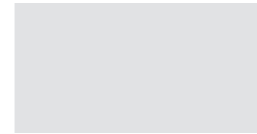

20 MM THICKNESS

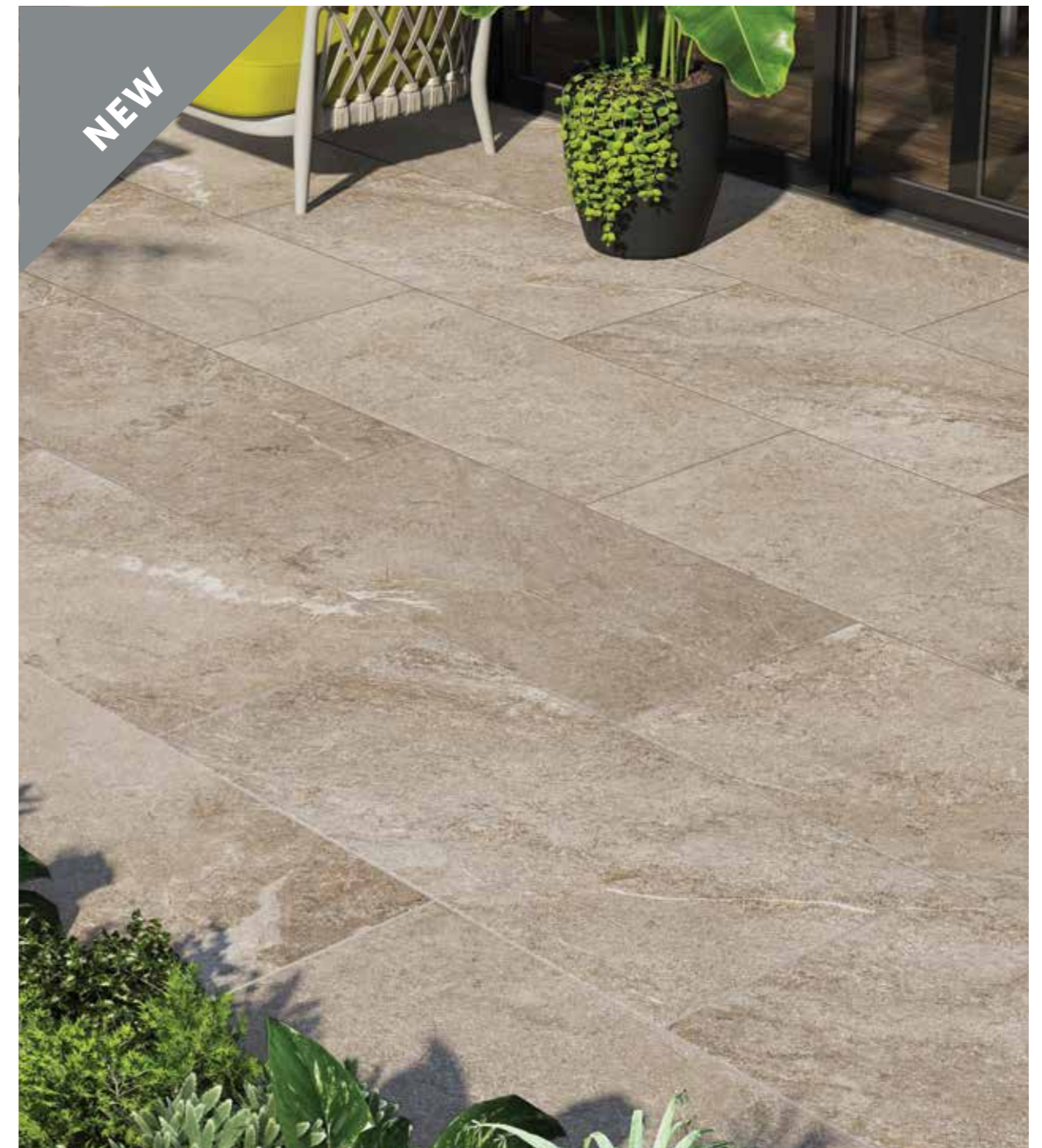
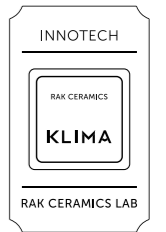

Stone Lagoon

PORCELAIN TILES

Matt • Rectified • Smooth



stone lagoon grey



stone lagoon sand

Name	R11 Code	Size(CM)
stone lagoon grey	A12GSNOG-GRY.Y6X7R	60x120 (R11)
stone lagoon sand	A12GSNOG-SND.Y6X7R	60x120 (R11)

Sizes (cm)	Thickness (mm)	Pieces X	M ² X	Kg X	X Eu. Pallet	M ² X Eu. Pallet	kg X Eu. Pallet
60x120	20	1	0.72	33	30	21.6	990

SIZES



60x120 cm

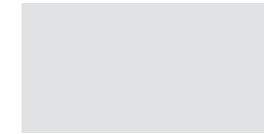

20 MM THICKNESS

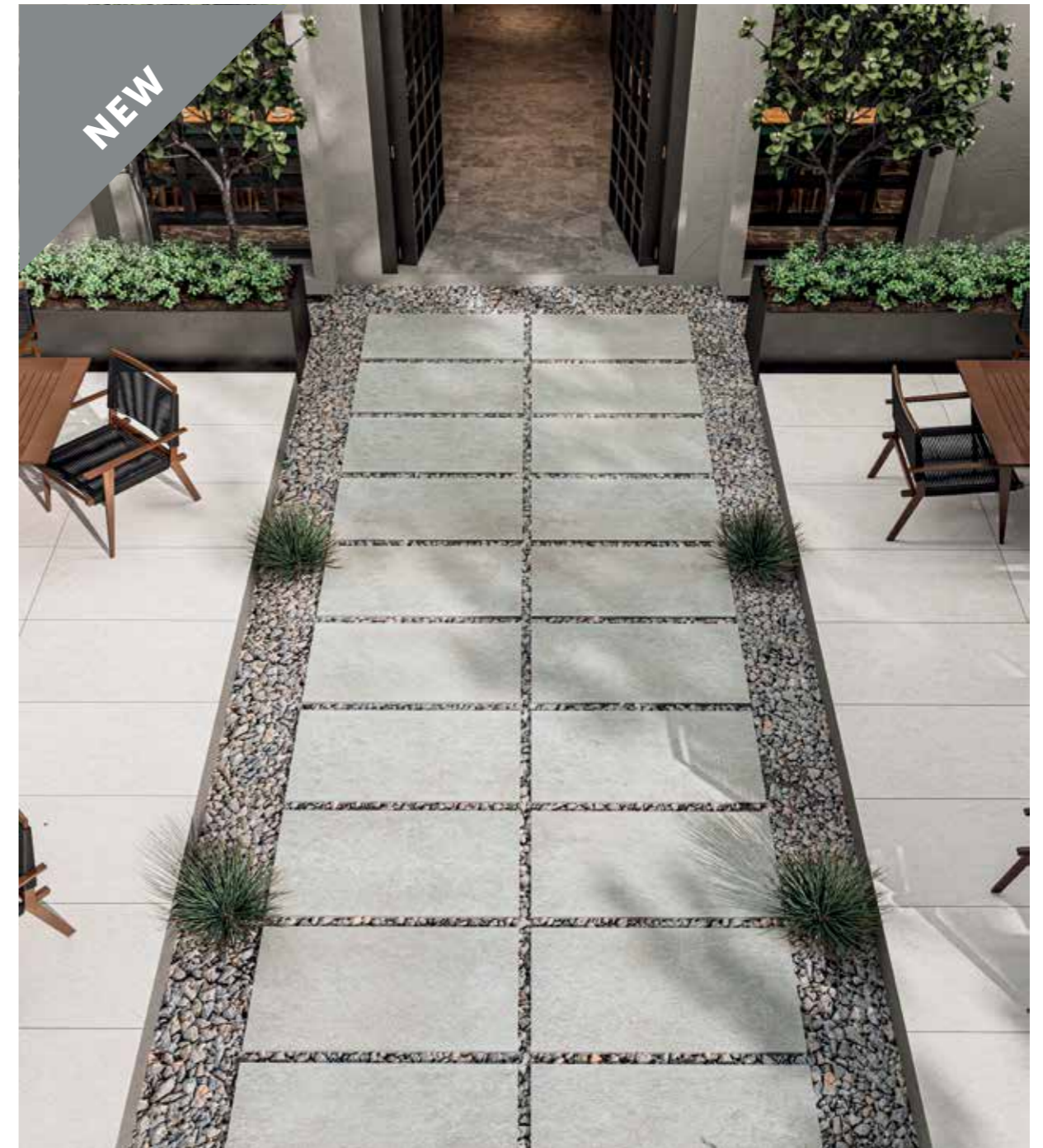
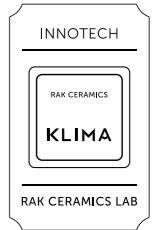

Surface 2.0 Outdoor

PORCELAIN TILES

Matt • Rectified • Smooth



surface 2.0 outdoor cool grey



surface 2.0 outdoor mid grey



surface 2.0 outdoor ash



surface 2.0 outdoor sand



surface 2.0 outdoor night

R11		
Name	Code	Size(CM)
surface 2.0 outdoor cool grey	Ao6GZSUR-CGY.MoT5R	60x60 (R11)
surface 2.0 outdoor mid grey	Ao6GZSUR-MGY.MoT5R	60x60 (R11)
surface 2.0 outdoor ash	Ao6GZSUR-ASo.MoT5R	60x60 (R11)
surface 2.0 outdoor sand	Ao6GZSUR-SNo.MoT5R	60x60 (R11)
surface 2.0 outdoor night	Ao6GZSUR-NTo.MoT5R	60x60 (R11)

Sizes (cm)	Thickness (mm)	Pieces X	M ² X	Kg X	X Eu. Pallet	M ² X Eu. Pallet	kg X Eu. Pallet
60x60	20	2	0.72	32	30	21.6	981

SIZES



60x60 cm



20 MM THICKNESS

Available in a matching indoor range – see page 172.



RAK
CERAMICS

PRODUCT GUIDE

TECHNICAL FEATURES

PORCELAIN TILES (BLA - GL):

Porcelain tiles are manufactured using pure, selectively imported raw materials mixed using the most advanced extraction and sorting techniques; they are obtained with a production process similar to that of single-fired tiles.

The resulting product is a top-quality porcelain tile, obtained by raw materials wet grinding, followed by partial drying by spraying, silo storage to allow homogenisation of properties, and pressing with highly efficient hydraulic presses up to specific pressures more than 500 kg/cm². The high pressure combined with high firing temperature exceeding 1200°C results in a highly compact and strong ceramic surface with very low water absorption (lower than 0.1% according to UNI EN ISO 10545-3) and extremely high mechanical resistance (average value exceeding 50 N/mm² according to UNI EN ISO 10545-4).

Thanks to their low porosity, these porcelain tiles are frost-proof and rated as belonging to the Bla GL class according to the European Standard UNI EN 14411 which requires water absorption ≤ 0.5%.

The MoR (modulus of rupture) in accordance with UNI EN ISO 10545-4 results to 50 N/mm² while the required value is 35 N/mm². RAK Ceramics porcelain tiles are available in a wide range of designs, sizes and finishes.

















ADVICE ON LAYING

Although our porcelain tiles can be installed using traditional cement mortars, we advise using modern adhesives. When installing on walls, the two layer spreading system is recommended to perfectly wet the back of the tile.

Quickly dipping each tile in water before installation will remove any dust on the back of the tile for perfect adhesion. Do not wet the tiles if you are using vinyl, acrylic resin adhesives or two-component organic-solvent based adhesive.

It is advisable to incorporate suitable shrinkage-flexion joints (movement/expansion joints) when installing on large floors: the joints should never be spaced more than 4-5 linear metres apart indoors and 3 linear metres apart outdoors. Be careful while using strong coloured grouts as they might leave stains on the surface of the tiles that may be difficult to remove later.

TECHNICAL CHARACTERISTICS - PORCELAIN TILES (BLA - GL)

Test Description	Standard Test Method	International Standard ISO 13006	RAK Ceramics Specifications	
			(Rectified)	(Unrectified)
 Length & Width	BS EN ISO 10545-2	+/- 0.6%	+/- 0.1%	+/- 0.3%
 Thickness	BS EN ISO 10545-2	+/- 5.0%	+/- 5.0%	+/- 5.0%
 Rectangle Squareness	BS EN ISO 10545-2	+/- 0.5%	+/- 0.2%	+/- 0.4%
 Straightness of sides	BS EN ISO 10545-2	+/- 0.5%	+/- 0.2%	+/- 0.3%
 Surface Flatness	BS EN ISO 10545-2	+/- 0.5%	+/- 0.3%	+/- 0.3%
 Water Absorption	BS EN ISO 10545-3	≤0.5%	≤0.4%	≤0.4%
 Modulus of Rupture	BS EN ISO 10545-4	≥35 N/mm ²	≥40 N/mm ²	≥40 N/mm ²
 Breaking Strength	BS EN ISO 10545-4	≥1300N	≥1600N	≥1600N
 Resistance to surface abrasion	BS EN ISO 10545-7	Manufacturer to state Abrasion Class	PEI Class 2-5	PEI Class 2-5
 Linear Thermal Expansion	BS EN ISO 10545-8	≤9x10 ⁻⁶ /°C	≤7x10 ⁻⁶ /°C	≤7x10 ⁻⁶ /°C
 Resistance to Thermal Shock	BS EN ISO 10545-9	No visible defect	No visible defect	No visible defect
 Crazing Resistance	BS EN ISO 10545-11	No crazing	No crazing	No crazing
 Frost Resistance	BS EN ISO 10545-12	No visible damage	No visible damage	No visible damage
 Resistance to chemicals	BS EN ISO 10545-13	No visible defect	No visible defect	No visible defect
 Resistance to stains	BS EN ISO 10545-14	Manufacturer to state class	Stain removed Min. class 4	Stain removed Min. class 4
 Colour Resistance to UV Light	DIN 51094	No change in colour	No change in colour	No change in colour

Note: Shade variation across the batches is inherent to the manufacturing process and the pre-laying colour comparison is recommended

TECHNICAL FEATURES

FULL BODY PORCELAIN TILES (BIA - UGL):

Full body porcelain tiles are manufactured using pure, selectively imported raw materials mixed using the most advanced extraction and sorting techniques; they are obtained with a production process similar to that of single-fired tiles. The resulting product is top-quality porcelain tile, obtained by raw materials wet grinding, followed by partial drying by spraying, silo storage to allow homogenisation of properties, and pressing with highly efficient hydraulic presses up to specific pressures more than 500 kg/cm². The high pressure combined with high firing temperature exceeding 1200 °C results in highly compact and strong ceramic surface with very low water absorption (lower than 0.1% according to UNI EN ISO 10545-3) and extremely high mechanical resistance (average value exceeding 40 N/mm² according to UNI EN ISO 10545-4).















Full body porcelain tiles are suitable for heavy traffic areas as they are characterised by a deep abrasion resistance (equal to 150 mm³ of removed material, as opposed to the 175 mm³ provided for by the UNI EN ISO 10545-6 standard). Thanks to their low porosity, these tiles are frost-proof and rated as belonging to the Bia UGL class according to the International Standard ISO 13006 and European Standard UNI EN 14411 which requires water absorption ≤ 0.5%. Chemical acid and base resistance (UNI EN ISO 10545-13) makes full body porcelain tiles suitable for environments where aggressive chemicals are used, e.g. food processing factories, hospitals, chemical or pharmaceutical plants. The full body porcelain tiles are available in a wide range of sizes and surfaces (slip-resistant finish also available).

ADVICE ON LAYING

Although our full body porcelain tiles can be installed using traditional cement mortars, we advise using modern adhesives. For large sizes over 40x40cm, outdoor and wall installations, the two-layer spreading system is recommended to perfectly wet the back of the tile. Quickly dipping each tile in water before installation will remove any dust on the back of the tile for perfect adhesion. Do not wet the tiles if you are using vinyl, acrylic resin adhesives or two-component organic-solvent based adhesive.

It is advisable to incorporate suitable shrinkage-flexion joints (movement/expansion joints) when installing on large floors: the joints should never be spaced more than 4-5 linear metres apart indoors and 3 linear metres apart outdoors. Be careful while using strong coloured grouts as they might leave stains on the surface of the tiles that may be difficult to remove later.

TECHNICAL CHARACTERISTICS - FULL BODY PORCELAIN TILES (BIA - UGL)

Test Description	Standard Test Method	International Standard ISO 13006	RAK Ceramics Specifications	
			(Rectified)	(Unrectified)
 Length & Width	BS EN ISO 10545-2	+/- 0.6%	+/- 0.1%	+/- 0.3%
 Thickness	BS EN ISO 10545-2	+/- 5.0%	+/- 5.0%	+/- 5.0%
 Rectangle Squareness	BS EN ISO 10545-2	+/- 0.5%	+/- 0.2%	+/- 0.4%
 Straightness of sides	BS EN ISO 10545-2	+/- 0.5%	+/- 0.2%	+/- 0.3%
 Surface Flatness	BS EN ISO 10545-2	+/- 0.5%	+/- 0.2%	+/- 0.3%
 Water Absorption	BS EN ISO 10545-3	<=0.5%	<=0.1%	<=0.1%
 Modulus of Rupture	BS EN ISO 10545-4	>=35 N/mm ²	>=40 N/mm ²	>=40 N/mm ²
 Breaking Strength	BS EN ISO 10545-4	>=1300N	>=1500N	>=1600N
 Resistance to deep abrasion	BS EN ISO 10545-6	<=175/mm ³	<=150/mm ³	<=150/mm ³
 Linear Thermal Expansion	BS EN ISO 10545-8	<=9x10 ⁻⁶ /°C	<=7x10 ⁻⁶ /°C	<=7x10 ⁻⁶ /°C
 Resistance to Thermal Shock	BS EN ISO 10545-9	No visible defect	No visible defect	No visible defect
 Frost Resistance	BS EN ISO 10545-12	No visible damage	No visible damage	No visible damage
 Resistance to chemicals	BS EN ISO 10545-13	No visible defect	No visible defect	No visible defect
 Resistance to stains	BS EN ISO 10545-14	Manufacturer to state class	Stain removed Min. class 2	Stain removed Min. class 2
 Colour Resistance to UV Light	DIN 51094	No change in colour	No change in colour	No change in colour

Note: Shade variation across the batches is inherent to the manufacturing process and the pre-laying colour comparison is recommended

TECHNICAL FEATURES

WHITE AND RED BODY CERAMIC TILES (BIII):

White and Red Body Ceramic tiles are made with finest quality clays and chamotte (a ceramic raw material with high percentage of silica). These raw materials are submitted to dry grinding and suitably mixed and wet and then pressed with hydraulic presses. Quick-cycle support firing is obtained via roller kilns reaching temperatures of approximately 1100°C. After biscuit glazing, the vitrified product is sintered in a single-layer roller kiln at approximately 10300°C. The resulting wall tiles have an average bending strength that is higher than 15/mrre in accordance with the UNI EN ISO10545-4 standard and a water absorption level that is higher than 10%; they belong to the BIII (GL) group according to the UNI EN 14411 standard. This class of products shows virtually no shrinkage during firing; therefore such dimensional consistency results in extremely easy laying.

ADVICE ON LAYING

White and Red Body Ceramic tiles can be laid using either tile adhesives or cement mortar. Under no circumstances should the tiles be wet before laying when using acrylic or vinyl resin based adhesives or two-component organic solvent based adhesives. When laying large sized tiles it is best to adopt the two-layer spreading method and, when the laying surface is very large, to provide for suitable expansion joints which must not be spaced more than 4-5 linear metres apart from one another.

IMPORTANT POINTS TO REMEMBER WHILE LAYING THESE TILES















When laying on wet concrete or plaster, leave to dry for at least one week for each centimetre of thickness.

When laying on brick, never lay on tile adhesive measuring more than 4-5mm in thickness. For laying on flexible supports (for example plasterboard panels, polymer panels, etc.) which may result in movement of the tiles, we advise laying on tile adhesive measuring no more than 2-3mm in thickness and to use class C2 or D1 glues.

For laying on waterproof brick, which prevents the release of damp, we advise laying on tile adhesive measuring no more than 3mm in thickness and to use class C2 or D1 glues.

Avoid laying without expansion joints or joints where stress due to expansion is released directly onto the tile.

TECHNICAL CHARACTERISTICS - RED BODY AND WHITE BODY CERAMIC TILES (BIII)

	Test Description	Standard Test Method	International Standard ISO 13006	RAK Ceramics Specifications
	Length & Width	BS EN ISO 10545-2	+/- 0.5%	+/- 0.3%
	Thickness	BS EN ISO 10545-2	+/- 10%	+/- 5.0%
	Rectangle Squareness	BS EN ISO 10545-2	+/- 0.5%	+/- 0.4%
	Straightness of sides	BS EN ISO 10545-2	+/- 0.5%	+/- 0.3%
	Surface Flatness	BS EN ISO 10545-2	+/- 0.5%	+/- 0.3%
	Water Absorption	BS EN ISO 10545-3	10% < E <= 20%	10% < E <= 18%
	Modulus of Rupture	BS EN ISO 10545-4		
	Thickness > = 7,5mm		>=12 N/mm2	>=16 N/mm2
	Thickness < = 7,5mm		>=15 N/mm2	>=16 N/mm2
	Breaking Strength	BS EN ISO 10545-4		
	Thickness > = 7,5mm		>=600N	>=650N
	Thickness < = 7,5mm		>=200N	>=400N
	Resistance to surface abrasion	BS EN ISO 10545-7	Manufacturer to state Abrasion Class	Class 2 - 4
	Resistance to Thermal Shock	BS EN ISO 10545-9	No visible defect	No visible defect
	Crazing Resistance	BS EN ISO 10545-11	No crazing	No crazing
	Resistance to chemicals	BS EN ISO 10545-13	No visible effect	No visible effect
	Resistance to stains	BS EN ISO 10545-14	Manufacturer to state class	Stain removed Min. class 4
	Scratch Hardness: (Moh's)	EN 101	-	4 - 6

Note: Shade variation across the batches is inherent to the manufacturing process and the pre-laying colour comparison is recommended

TECHNICAL FEATURES

GRES WHITE BODY TILES (BIIA):

Gres white body tiles are created by mixing raw materials including high quality white or red clays, quartz and feldspar in wet grinding ball mills. After grinding, a clay-based suspension of these materials called a slip is fed out of the mill then spray-dried to remove excess moisture. Following the spray drying process, the free flowing powder is pressed using advanced hydraulic presses with a specific pressing power exceeding 300 kg/cm² in order to obtain a compact gres body. Once dried, the tiles are coated and decorated with glazes to make them aesthetically pleasing and meet our customers' design requirements.

The glazed tile body is then fired in roller kilns where temperatures of approximately 1200 °C are reached. The resulting product is normally a medium-to-low porosity (3% to 5%) tile, in compliance with the International Standard ISO 13006 and European Standard UNI EN 14411 standard and rated as belonging to the BIIa GL group with notable technological specifications such as the product flexural strength (average value: 30N/mm² according to UNI EN ISO 10545-4).

As for wear resistance, this will depend on the type and colour of glazing and may change according to different products or collections. As a general rule, bright finishes are not recommended for heavy traffic floors or rooms opening onto outdoor areas, where sand or other abrasive materials are more likely to be brought in.

















ADVICE ON LAYING

Our gres white body tiles can be laid using either traditional cement mortar or modern tile adhesives. When laying large size tiles, it is best to adopt the two-layer spreading system to ensure the adhesive is spread over 90% of the tile surface. Quickly dipping each tile in water before installation will remove any dust on the back of the tile for perfect adhesion, however, do not wet the tiles if you are using vinyl, acrylic resin adhesives or two-component organic-solvent based adhesive.

It is advisable to always incorporate suitable shrinkage-flexion joints (movement/expansion joints) which must not be spaced more than 4-5 metres apart from one another. These joints must be inserted not only between the tiles, but also reach the levelling compound below, consisting of either cement mortar or dry compound, depending on whether the tiles are set in the traditional manner or using a modern adhesive. The movement joints must be sealed with appropriate materials such as silicone or polyurethane-based sealants, depending on the anticipated traffic of the application area.

Appropriate tile bedding layers should be used such as underlay, damp course, vapour barrier or any other layer necessary to prevent the tiles from detaching themselves or cracking due to water penetration.

TECHNICAL CHARACTERISTICS - GRES WHITE BODY TILES (BIIA)

	Test Description	Standard Test Method	International Standard ISO 13006	RAK Ceramics Specifications
	Length & Width	BS EN ISO 10545-2	+/- 0.6%	+/- 0.3%
	Thickness	BS EN ISO 10545-2	+/- 5.0%	+/- 5.0%
	Rectangle Squareness	BS EN ISO 10545-2	+/- 0.5%	+/- 0.4%
	Straightness of sides	BS EN ISO 10545-2	+/- 0.5%	+/- 0.3%
	Surface Flatness	BS EN ISO 10545-2	+/- 0.5%	+/- 0.4%
	Water Absorption	BS EN ISO 10545-3	3% < E <= 6%	3% < E <= 5%
	Modulus of Rupture	BS EN ISO 10545-4	>=22 N/mm ²	>=30 N/mm ²
	Breaking Strength	BS EN ISO 10545-4		
	Thickness >= 7.5mm		>=1000N	>=1100N
	Thickness <= 7.5mm		>=600N	>=800N
	Resistance to surface abrasion	BS EN ISO 10545-7	Manufacturer to state Abrasion Class	Class 2 - 4
	Resistance to Thermal Shock	BS EN ISO 10545-9	No visible defect	No visible defect
	Crazing Resistance	BS EN ISO 10545-11	No crazing	No crazing
	Resistance to chemicals	BS EN ISO 10545-13	No visible effect	No visible effect
	Resistance to stains	BS EN ISO 10545-14	Manufacturer to state class	Stain removed Min. class 4
	Scratch Hardness: (Moh's)	EN 101	-	4 - 6

Note: Shade variation across the batches is inherent to the manufacturing process and the pre-laying colour comparison is recommended

MAINTENANCE AND CLEANING OF TILES

Maintenance of ceramic and porcelain tiles on dry surfaces is relatively easy. RAK Ceramics tiles are highly scratch and stain resistant.

- By regularly sweeping the floor, you can help avoid scratches that small pebbles or sand can create.
- Make it a habit to always wipe the soles of your shoes on a mat before entering the house. Thoroughly wipe up any spills using plain warm water.
- While they are not likely to stain your ceramic tiles, spills may stain the grout between the tiles and if they are left to sit for too long, may also stain the actual tiles.
- Plain water is the ideal cleaner because it leaves no residue if you dry the surface of the tiles thoroughly after cleaning.
- If tiles are left wet after cleaning, there may be some unsightly mineral residue after the water dries, but this can easily be removed by spot cleaning.
- If stains resist cleaning with water alone, you can use a mild acidic solution, such as white vinegar. Use it highly diluted and rinse with plain water then dry.
- As food stains are acidic in nature, try using a mild alkaline solution.
- Use common detergents sparingly, rinse with plain water and dry thoroughly.

RAK CERAMICS CARE: EXCLUSIVE POST-INSTALLATION CLEANING SERVICE

We have collaborated with Fila, a leading company in cleaning, protection and maintenance of ceramic surfaces, to offer an exclusive cleaning service to address our customers' post-installation concerns.

Cleaning after laying is of vital importance as a lot of unseen debris and reactive chemicals can affect the visual appearance of the ceramic material. With this new service, our customers can take advantage of Fila's professional on-site consultation. For more info please visit www.rakceramics.com



FILA IS A RECOMMENDED PARTNER OF RAK CERAMICS

TILE-LAYING RECOMMENDATIONS

All RAK Ceramics products are subject to size and shade variations. Please check the size, batch number, calibre, tone, choice, colour, and quality of the pieces before the installation, as no claims will be accepted once the tiles are installed.

Place some tiles on the floor – 2 or 3 sqm – and check the overall technical and aesthetic characteristics with care. Check if there is enough product to finish the work.

Manufacturer's responsibility is only limited to replacement of defective material if any, prior to fixing of tiles, and we will not entertain claim of any nature after the tiles are installed.

Therefore, if any issue is found on the delivered product, the contractor for installation or the client should not install the tiles. The issue should be communicated to RAK Ceramics for investigation and further action for resolution as required.

The substrate must be a compact cement bed. Levelling system ensures flatness between tiles avoiding movements during the mortar setting. This reduces the time for the ceramic laying, obtaining a perfect lippage-free finish. Avoid movements between the tiles due to the mortar setting.

The width of grout joints must be established by the installation supervisor, unless grout widths are regulated by national laying standards. The grout colour should be selected according to the colour of the tile. We recommend to select a matching colour. Before using fine-grain coloured grout on lapped, polished or brushed products, always test it. If the pigment is very adhesive, it may be very difficult to remove.

We recommend to lay the tiles by using suitable adhesives for each kind of product and surface. As a general rule, tiles must be installed in the same position. The minimum joint is 2mm for rectified tiles, although we suggest a higher joint for big size products. After grouting, remove any excess product as quickly as possible by repeatedly washing the area with a sponge and water.

Steps to follow:

1. First, set the tool to the scale according to the ceramic thickness.
2. Introduce the crossheads and continue laying the adjacent tiles.
3. Put the wedges in the crosshead manually.
4. Tighten the wedges with the pliers to level the pieces.
5. Allow for setting for the time recommended by the manufacturer of the adhesive cement.
6. Remove the crossheads. Hit the crosshead with a rubber mallet or with your foot in the direction of the joint. Do not hit the wedges.

The company will not accept any claim if this is due to the problems caused by not following these suggestions and instructions.

R RATING TABLE

Collections	Typology	Colours	R (matt)	R 
Basic Concrete	Porcelain Tiles	Grey	R9	-
		Beige	R9	-
		Dark Grey	R9	-
		Dark Beige	R9	-
Calacatta Gold Outdoor	Porcelain Tiles	White	-	R11
Calacatta Grey Outdoor	Porcelain Tiles	White	-	R11
Carmo Stone	Porcelain Tiles	Grey	R10	R11
		Anthracite	R10	R11
		Ivory	R10	R11
		Black	R10	R11
Circle Wood	Porcelain Tiles	Ivory	R10	-
		Grey	R10	-
		Nut	R10	-
		Beige	R10	-
		Brown	R10	-
City Stone	Porcelain Tiles	Bone	R10 / A	-
		Grey	R10 / A	-
		Anthracite	R10 / A	-
Clay Stone	Porcelain Tiles	Clay	R10 / A	-
		Grey	R10	-
		Dark Grey	R10	-
Clay Stone	Porcelain Tiles	White	R10	-
		Beige	R10	-
		Beige	R10	-
Curton	Full Body Porcelain Tiles	White	R10 / A+B	R11 / A+B (Decor)
		Taupe	R10 / A+B	R11 / A+B (Decor)
		Grey	R10 / A+B	R11 / A+B (Decor)
		Beige	R10 / A+B	R11 / A+B (Decor)
Fashion Stone	Porcelain Tiles	Light Grey	R10 / A	R11 / A+B (60x60, 20mm thickness)
		Grey	R10 / A	R11 / A+B (60x60, 20mm thickness)
		Black	R10 / A	R11 / A+B (60x60, 20mm thickness)
		Ivory	R10 / A	R11 / A+B (60x60, 20mm thickness)
		Beige	R10 / A	R11 / A+B (60x60, 20mm thickness)
		Clay	R10 / A	R11 / A+B (60x60, 20mm thickness)
Lapideus	Full Body Porcelain Tiles	White	R10 / A+B+C	-
		Black	R10 / A+B+C	-
		Slate Grey	R10 / A+B+C	-
		Dark Grey	R10 / A+B+C	-
		Beige	R10 / A+B+C	-
		Original	R10 / A+B+C	-
Line Wood	Porcelain Tiles	Pece	R10 / A+B+C	-
		Ivory	R10 / A	R11 / A+B
		Beige	R10 / A	R11 / A+B
		Dark Beige	R10 / A	R11 / A+B
		Brown	R10 / A	R11 / A+B
Line Wood	Porcelain Tiles	Dark Brown	R10 / A	R11 / A+B

Collections	Typology	Colours	R (matt)	R 
Loft Concrete	Porcelain Tiles	Dark Grey	R9	-
		Ivory	R9	-
		Light Beige	R9	-
		Silver Grey	R9	-
		Warm Grey	R9	-
Lounge	Full Body Porcelain Tiles	Grey	R9 / A	R11 / A+B
		Anthracite	R9 / A	R11 / A+B
		Dark Anthracite	R9 / A	R11 / A+B
		Black	R9 / A	R11 / A+B
		Ivory	R9 / A	R11 / A+B
		Light Grey	R9 / A	R11 / A+B
		Beige	R9 / A	R11 / A+B
Maremma	Porcelain Tiles	Mocca	R9 / A	R11 / A+B
		Steel	R10	-
		Grey	R10	R11
		Sand	R10	R11
		Copper	R10	R11
Paleo	Porcelain Tiles	White	R10 / A	-
		Anthracite	R10 / A	-
		Grey	R10 / A	-
		Warm Grey	R10 / A	-
		Beige	R10 / A	-
		Clay	R10 / A	-
RAK Stone 2.0 Outdoor	Porcelain Tiles	Grey	-	R11
Rapolano Marble	Porcelain Tiles	Beige	R9	-
		Light Beige	R9	-
		White	R9	-
Shine Stone	Porcelain Tiles	Grey	R9	-
		White	R11 / A+B	-
		Dark Grey	R11 / A+B	-
		Ivory	R11 / A+B	-
Surface 2.0	Porcelain Tiles	Beige	R11 / A+B	-
		Cool Grey	R10 / A+B	-
		Mid Grey	R10 / A+B	-
		Ash	R10 / A+B	-
		Off White	R10 / A+B	-
		Sand	R10 / A+B	-
Surface 2.0 Outdoor	Porcelain Tiles	Night	R10 / A+B	-
		Cool Grey	-	R11 / A+B (20mm thickness)
		Ash	-	R11 / A+B (20mm thickness)
		Night	-	R11 / A+B (20mm thickness)
Symphony	Porcelain Tiles	Mid Grey	-	R11 / A+B (20mm thickness)
		Sand	-	R11 / A+B (20mm thickness)
		Star 1	R10	-
		Star 2	R10	-
		Gaudi A	R10	-
		Gaudi B	R10	-
		Ornamental 1	R10	-
		Ornamental 2	R10	-
Ornamental 3	R10	-		
Symphony	Porcelain Tiles	Petals A	R10	-
		Petals B	R10	-

PACKAGING DETAILS

A-Frame Vertical Pallet

PALLET DIMENSIONS (CM)

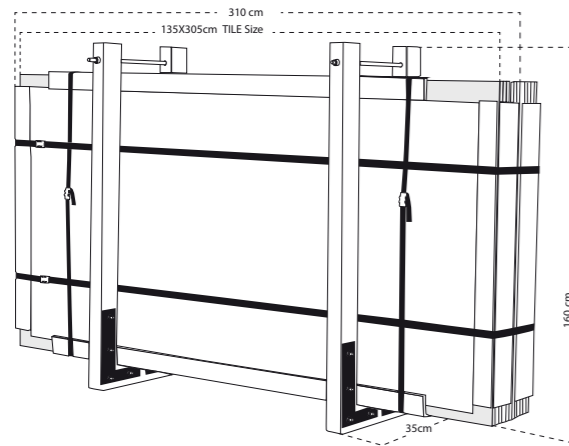

Finish	Length	Height	Width
Polished / Natural	310	160	35

Horizontal Pallet

PALLET DIMENSIONS (CM)

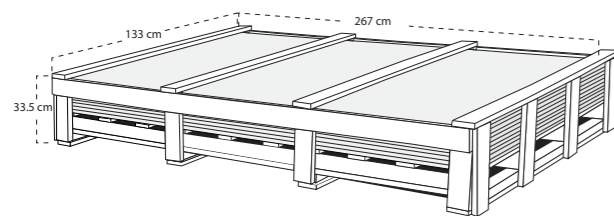

Finish	Length	Height	Width
Polished / Natural	267	33.5	133

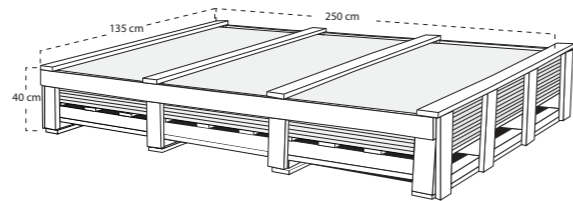

Finish	Length	Height	Width
Polished / Natural	250	40	135

Box Pallet

PALLET DIMENSIONS (CM)

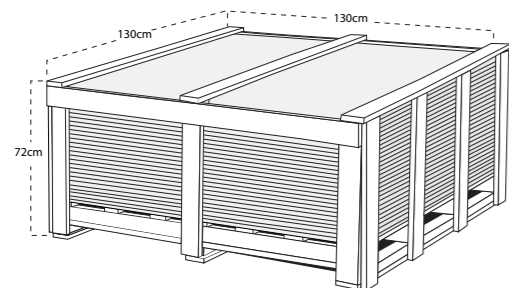

Finish	Length	Height	Width
Polished / Natural	130	72	130

Note: All tile dimensions mentioned above are rectified. Unrectified size is available in +/-140x308cm on request
All weights and thickness mentioned in the above table are approximate average.

TECHNICAL MANUAL

HANDLING MAXIMUS:

- Maximus extra-large format slabs arrive in oversized crates, which require specific handling equipment to prevent from damage occurring during forklift operation, specific fork sizes must be used. For example, to handle a crate of 135x305cm tiles from the side, 112cm/44" long forks are recommended.
- To handle the same crate from the narrow end requires forks that are at least 213cm/84" long. Lifting multiple crates with longer forks may require forklifts with a greater lift capacity.
- Specialised tools and equipment are currently available for the handling, installation and cutting of large porcelain surfaces. Innovative trowels with unique notch configurations can help increase the consistency of the mortar coverage on the back of the tile.
- To increase rigidity and limit twisting, use a system composed of parallel and transverse guides.
- For a perfect adhesion, clean the slab and the suckers with a damp sponge.
- The suckers run along the guides and adhere to the slab. Make sure that a vacuum is created between the device and the surface.
- A single guide device can be used for sizes of maximum length.
- Use four operators at a time to carry out handling operations of large size slabs.
- Lift the slab along the long side and hang it vertically to the handles of the frame.
- For the large size slab, a suitably reinforced trolley is recommended. Set the guides to the trolley for carrying the slab.
- Follow the same procedure for handling the 120x240cm and all other sub-sizes, where only two operators are sufficient.

CUT-TO-PIECES AND DRILLING

- RAK Ceramics recommends the use of special designed devices for handling as well as cutting and laying of big slabs.
- Handle slab with a proper and professional trolley of aluminum parallel profile with crossbars and vacuum suction cups along with a vacuum gauge. Please use double suction cups for slabs above 300cm. This could make sure that appropriate vacuum is created between the device and the slab. Lift the slab and keep it vertically to the trolley frame.
- Keep the slab on a stable, flat and intractable surface. For successful cutting and drilling, RAK Ceramics recommends using a professional modular workbench with aluminum profiles and proper cutting tools for each type of cut.
- Set the cutting unit on the tile so that the references coincide with the marked lines and lock it with the appropriate suckers. Score the slab from one edge to the other, being careful to maintain the same pressure while moving.
- When the cut has been made, move the slab until the slit line sticks out 10 to 15cm from the workbench. Start hew from both sides using appropriate cutting-off pliers and follow the scoring line to complete the hew.
- Smooth rough edges and sides with an appropriate diamond polishing pad.
- To drill internal cutouts from the slab, first you need to draw the guide lines. For circular cuts, use the compass device with suction cups. For rectangular cuts, drill first a 5 to 7mm hole at the corners of the rectangle shape, using a non-percussion drill. For better drilling, always keep the surface and drill a little bit wet. Then follow the drilled lines using a diamond-blade angle grinder and finish off the edges with a diamond-polishing pad. Round holes (4) must be made in wet drilling, using diamond-blades. Start engraving the surface with a 75° point angle, then straighten out the drill avoiding excessive pressure on the slab. Also, in this case finish with a diamond-polishing pad.
- Manual traction devices are available, in order to make a finishing cut at 45° and thus enable special applications of the material.

TECHNICAL MANUAL

INSTALLATION:

Laying Maximus slabs requires similar laying conditions to those required for traditional format slabs. Maximus slabs require the adhesive to be applied both on the setting bed and on the back of the slab.

MAXIMUS SLABS FOR FLOORING REQUIRE THE FOLLOWING CONDITIONS:

- A flat surface that is clean and free from dust, scraps and any lumps of cement.
- The setting bed must be uniform and have already undergone the dry shrinkage process.
- Repair any cracks.
- Any uneven parts on the surface must be filled with suitable levelling compounds.

INSTRUMENTS REQUIRED:

- Cement-based powder adhesive for full spread, class C2E according to EN12004 and S1 according to EN12002 standards.
- 3x3mm square toothed trowel and 15mm round toothed trowel.
- Frame with suction cups for handling or double suction cups.
- Non-bounce plastic mallet 170x370mm.
- Levelling system: base clip + wedge + pliers.

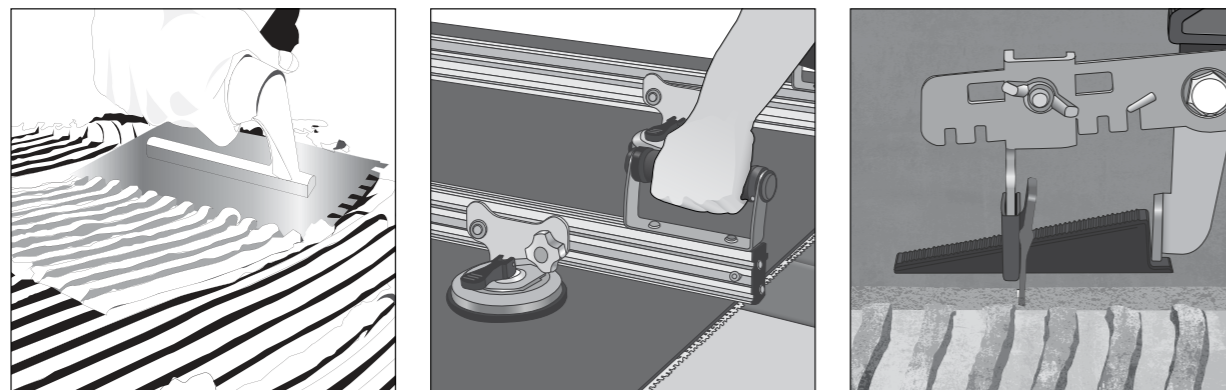

BONDING TO THE FLOOR:

Ensure that the surface to be covered is solid, flat and free from dust and oil/grease.

- Use the adhesives described on page 254 mixed according to the specifications indicated in the technical data sheet of the chosen adhesive.
- Spread the adhesive onto the surface to be covered with a 15mm round toothed trowel across an area of 5/10cm more than the dimensions of the slab.
- With the slab in a vertical position on the handling frame, spread the adhesive onto the back of the slab with a 3x3mm square toothed trowel.
- Using the frame with suction cups, bring the slab into a horizontal position and lay it.
- To guarantee uniform bonding of the slab, the special 170x370mm non-bounce plastic mallet must be used, tapping from the middle towards the edges so as to remove any air pockets between the back of the slab, the adhesive and the surface to be tiled using the levelling system.

BONDING TO THE WALL:

- Ensure that the surface to be covered is solid, flat and free from dust.
- Cement-based powder adhesive for full spread, class C2E according to EN12004 and S1 according to EN12002 standards.
- Spread the adhesive onto the surface to be covered with a 15mm round toothed trowel across an area of 5/10cm more than the dimensions of the slab.
- With the slab in a vertical position on the handling frame, spread the adhesive onto the back of the slab with a 3x3mm square toothed trowel.
- Using the handling frame in a vertical position, lay the slab.
- Before releasing the slab from the handling frame, ensure that the adhesive will hold it in place.
- To guarantee complete bonding of the slab and eliminate any air, tap from the middle towards the edges using the non-bounce plastic mallet.
- Before bonding the next slab, fix the hidden mechanical hook to the wall with the relevant nails (length 27mm) using the gas-powered nailing machine.

GROUT FILLING:

- Use professional and high quality grouting products.
- While stirring, pour the grout into a clean and rust free container, containing 22/26 percent by weight of clean water.
- Mix the grout with a low-speed mixer to avoid air entrapment, until a smooth paste is obtained.
- Let the mix stand for 2 to 3 minutes. Stir again briefly before use.
- Use the mixture within 20 to 25 minutes of its preparation.
- Fill the joints with a special grout float or rubber squeeze without leaving any gaps or steps. Remove any excess grout and leave for 15 to 30 minutes.
- Clean off the excess mixture with a hard, damp sponge, working in a diagonal direction to the joints.



CLEANING & MAINTENANCE:

Maximus products are non porous (due to their high quality raw materials, stringent production parameters and state of the art technology), hence any dust or deposited waste cannot penetrate the surface. For most cases, only a damp cloth is sufficient for cleaning. Regular cleaning highlights the aesthetic features of the surface and gives it exceptional shine.

NOTES

WARRANTIES

WARRANTY

Whilst every RAK Ceramics product is manufactured to the highest standards, RAK Ceramics offers the following limited warranty as additional support to our customers.

RAK Ceramics Branded Products are covered by the following warranty period:

Product:	Warranty Period:
Tiles	10 Years

DISTRIBUTORS



COLLINSON CERAMICS
31 Roseburn Street
Edinburgh
EH12 5PE
TEL: 0131 313 3577
EMAIL: hello@collinson-ceramics.co.uk



BOYDEN TILES & BATHROOMS
108 Beddington Lane
Croydon
Surrey
CR0 4YY
TEL: 020 8683 6000
EMAIL: sales@boydentiles.co.uk



TILE & CERAMIC SOLUTIONS LTD
6A Cartwright Court
Bradley Business Park
Huddersfield
HD2 1GN
TEL: 01484 320040
EMAIL: sales@uktcs.com



WALLS AND FLOORS
Garrard Way
Kettering
NN16 8TD
TEL: 01536 410484
EMAIL: wholesale@wallsandfloors.co.uk

TPOLOGY	EDGE	SURFACE STRUCTURE
RED BODY CERAMIC TILES	STRAIGHT	SMOOTH
WHITE BODY CERAMIC TILES	RECTIFIED	LIGHT STRUCTURE
GRES WHITE BODY TILES	SHAPED	HEAVY STRUCTURE
PORCELAIN TILES		
FULL BODY PORCELAIN TILES		

SURFACE LOOK	COLOUR VARIATIONS	INDICATIONS FOR USE
MATT	V1 EVEN	COUNTERTOP SURFACE
SATIN	V2 LIGHT	WALL TILES
GLOSSY	V3 MEDIUM	FLOOR TILES
HIGH GLOSSY	V4 STRONG	

SUGGESTED APPLICATIONS		
DOMESTIC PURPOSE	LIGHT COMMERCIAL TRAFFIC AREA	FACADE
OUTDOOR	HEAVY COMMERCIAL TRAFFIC AREA	INDUSTRIAL TRAFFIC AREA

IN PRINTING, COLOUR OF THE PRODUCTS MAY DIFFER SLIGHTLY FROM ACTUAL, PICTURES ARE ONLY FOR REFERENCE.

RAK CERAMICS
Bradford House,
Frenchmans Road,
Petersfield,
GU32 3AW
Tel: 01730 237850
Email: info.uk@rakceramics.com
RAKCERAMICS.COM

RAK
CERAMICS

CODE: RAK24/USURFACES

RAK
CERAMICS

Surfaces Porcelain and Ceramics

2024