

ORIDIAN INSET IGNEOUS GRANITE SINK

ORI7901CH/



Size: 790 x 500 mm

Create a modern finished look with the addition of an Oridian granite bowl.

The Oridian collection features large bowls offering ample space to wash large pots and pans, available in separate inset and undermount collections.

- Igneous granite material, 80% quartz & 20% acrylic
- Large bowls
- Separate inset and undermount collections
- Waste kit included

RANGEMASTER

SINKS & TAPS

Material	Igneous Granite
Material Gauge	-
Material Finish Bowl	-
Material Finish Drainer	-
Drainer Position	
Overall Length (mm)	790
Overall Width (mm)	500
Main Bowl Length (mm)	720
Main Bowl Width (mm)	400
Main Bowl Depth (mm)	200
Second Bowl Length (mm)	-
Second Bowl Width (mm)	-
Second Bowl Depth (mm)	-
Tap hole Size (mm)	1 x 35
Waste Size (mm)	1 x 90
Waste Kit	Included with sink (2 x 89mm BSW & overflow kit)
Min. Base Unit (mm)	800
Cutout Size Length (mm)	770
Cutout Size Width (mm)	480
Warranty Sinks (years)	20
Product Code	ORI7901CH/
Barcode	5015834056739

Date of download: August 23, 2024

AGA Rangemaster continuously seeks improvements in specification, design and production of products and thus, alterations take place periodically. Whilst every effort is made to produce up-to date resources, the information included here is intended as a guide. Always refer to the product's installation instructions when fitting, installation work should be completed a professional tradesman.

ORIDIAN INSET IGNEOUS GRANITE SINK

ORI7901CH/

Technical Drawing

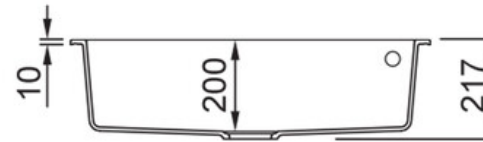
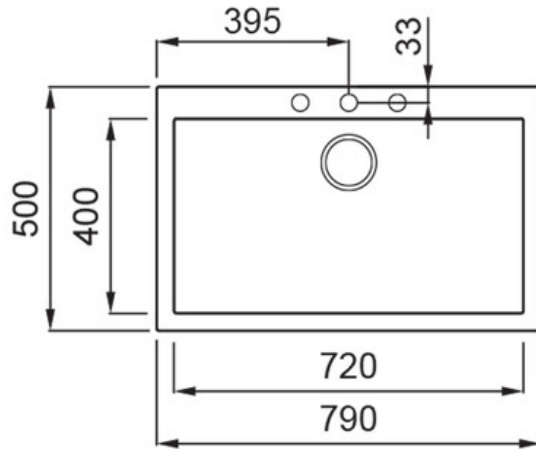

Date of download: August 23, 2024

AGA Rangemaster continuously seeks improvements in specification, design and production of products and thus, alterations take place periodically. Whilst every effort is made to produce up-to date resources, the information included here is intended as a guide. Always refer to the product's installation instructions when fitting, installation work should be completed a professional tradesman.

ORIDIAN INSET IGNEOUS GRANITE SINK

ORI7901CH/

Cut Out Template

Dimensions in mm. Not to scale.

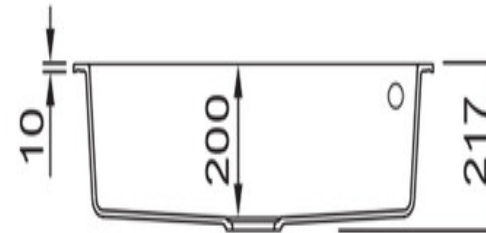
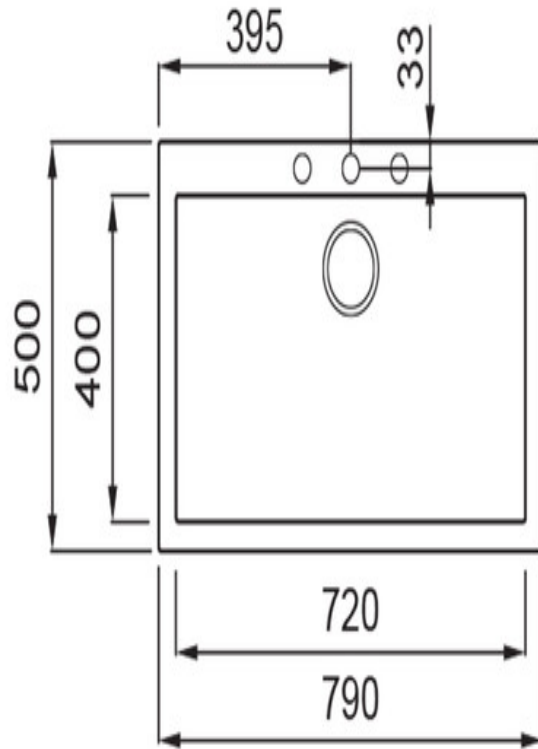

Date of download: August 23, 2024

AGA Rangemaster continuously seeks improvements in specification, design and production of products and thus, alterations take place periodically. Whilst every effort is made to produce up-to date resources, the information included here is intended as a guide. Always refer to the product's installation instructions when fitting, installation work should be completed a professional tradesman.