

SAGITTARIUS

TAPS & SHOWERING

Core material :	Brass bar (CuZn38Pb2), forged brass (CuZn38Pb2) & brass tube (CuZn37)
Design standard :	BS EN 200 Sanitary tapware - General technical specification
Handle :	Zinc alloy
Finishing :	Chrome plated to BS EN 248 (nickel plating 8-10 um & chromium plating 0.2-0.25um)
Cartridge :	1/4 turn 1/2" ceramic disc valve
Fitting :	15mm BSP
Connecting hoses :	-
Aerator :	Air Aerator
Approval :	CE
Packaging :	PE laminated foam + packaging

AVANT 3 HOLE WALL MOUNTED BASIN MIXER AV/171/C

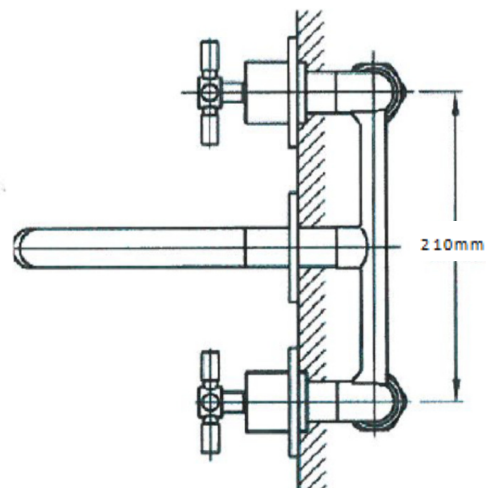
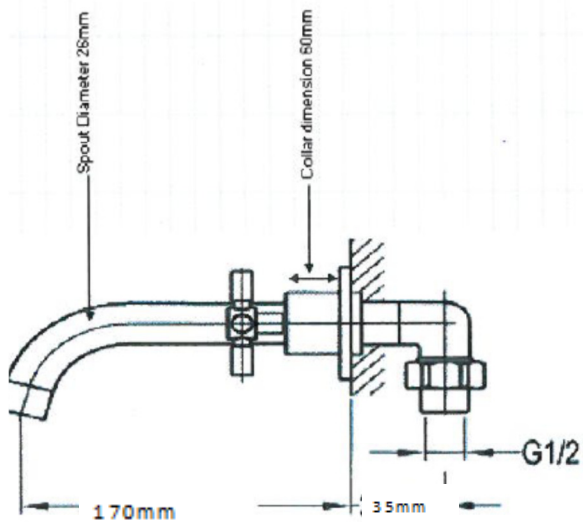

The information contained on this page was correct at the date of issue. Fitting dimensions are provided as a guide only. Some variation may occur due to manufacturing tolerances. We pursue a policy of continuing improvement in design and performance of our products and so reserve the right to change specifications without prior notice

FOR FURTHER ADVICE PLEASE CONTACT :-
SAGITTARIUS LTD UNIT 1 LOWER VICTORIA STREET—CHADDERTON—OLDHAM—OL9 9TU TEL:0616 6202029
EMAIL:TECHNICAL@SAGITTARIUSTAPS.CO.UK